

LAME PER CARRI DESILATORI

www.stellalame.com

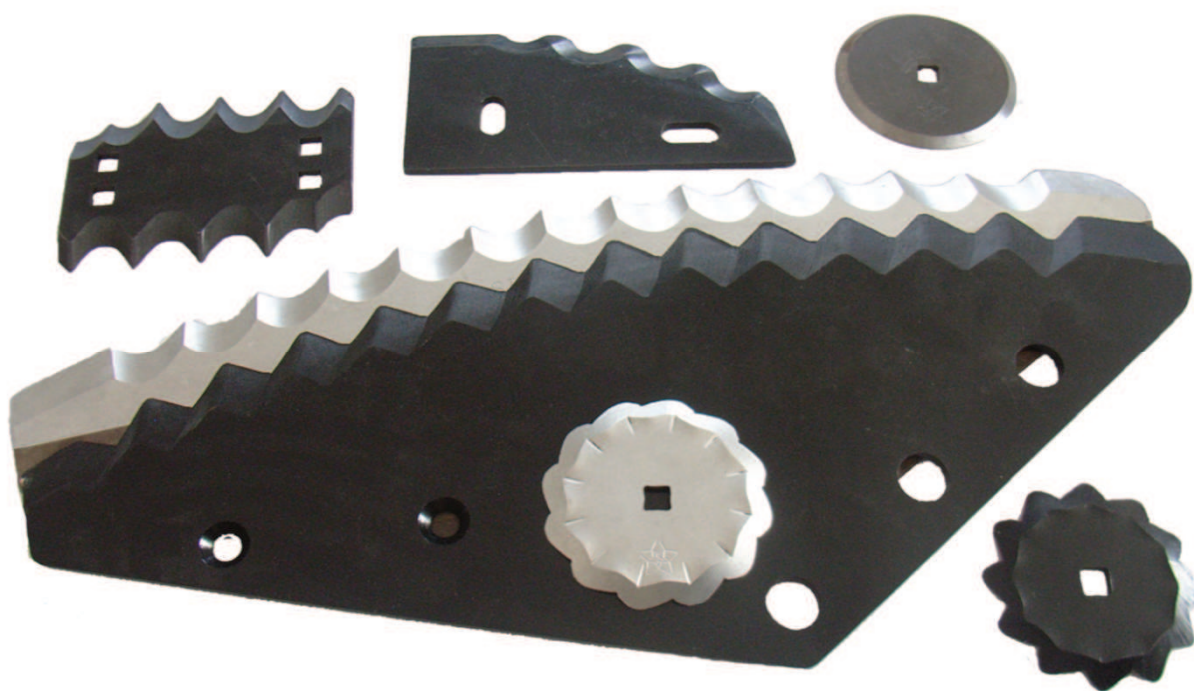

LAME PER CARRI DESILATORI - BLADES FOR SHREDDER MIXER
KLINGEN FÜR SILOSENLADER - LAMES POUR EXTRACTEUR MELANGEURS
CUCHILLAS DESMENUZADORAS PARA CARROS MEZCLADORES
НОЖИ ДЛЯ МИКСЕРОВ-КОРМОРАЗДАТЧИКОВ

Codice

Adattabili a:

Codice

Adattabili a:

D2001 L f.6,25

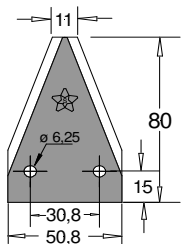

Liscia
 Spess. 2,5
 Varie
 Storti 16800008
 Mutti
 Luclar
 Feraboli
 DeLaval

D2001 L f.6,25 P

** L'angolo di piegatura può essere realizzato su richiesta

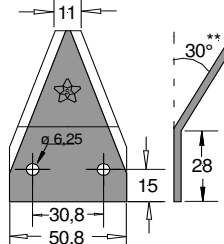

Liscia
 Spess. 2,5
 Varie
 Mutti
 DeLaval

D2001 L x 3 f.6,25

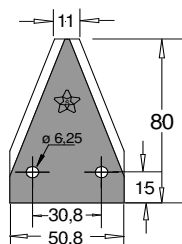

Liscia
 Spess. 3
 Sgariboldi
 Luclar
 Varie

D2001 L x 3 f.6,25 P

** L'angolo di piegatura può essere realizzato su richiesta

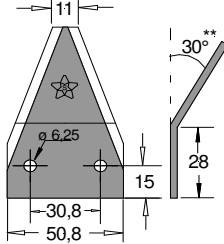

Liscia
 Spess. 3
 Luclar
 Varie

D2001 L x 3 f.6,25 DX

** L'angolo di piegatura può essere realizzato su richiesta

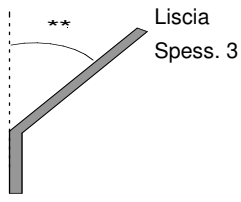
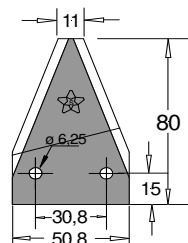

Varie

D2001 L x 3 f.6,25 SX

** L'angolo di piegatura può essere realizzato su richiesta

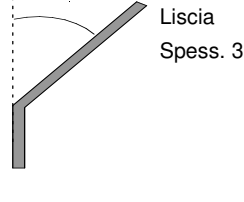
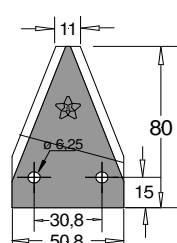

Varie

D2001 S f.6,25

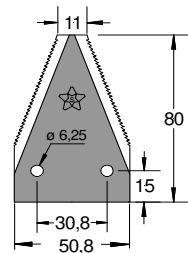

Sotto rigata
 Spess. 2,5
 Varie

D2001 S x 3 f.6,25

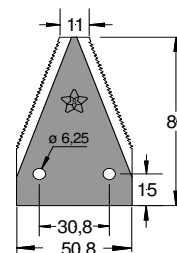

Sotto rigata
 Spess. 3
 Varie

D2001 S x 3 f.8,5

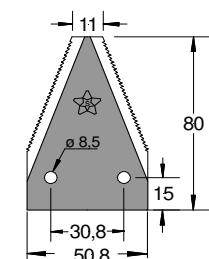

Sotto rigata
 Spess. 3
 Varie

D2001 L 6 fori

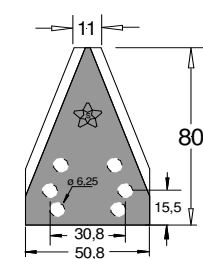

Liscia
 Spess. 2,5
 DeLaval 94832801
 Storti 1680002600



LAME PER CARRI DESILATORI - BLADES FOR SHREDDER MIXER
KLINGEN FÜR SILOSENLADER - LAMES POUR EXTRACTEUR MELANGEURS
CUCHILLAS DESMENUZADORAS PARA CARROS MEZCLADORES
НОЖИ ДЛЯ МИКСЕРОВ-КОРМОРАЗДАТЧИКОВ

Codice

Adattabili a:

Codice

Adattabili a:

D2001 S x 3 f.8,5 DX

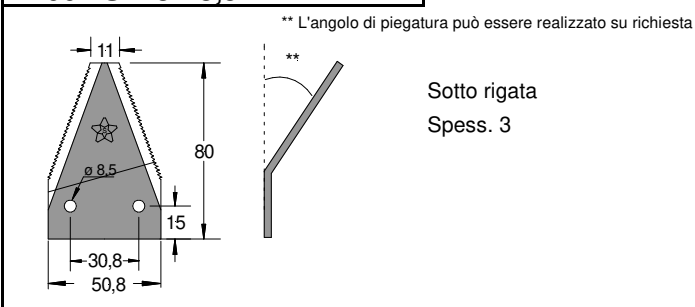

Sotto rigata
Spess. 3

D2001 S x 3 f.8,5 SX

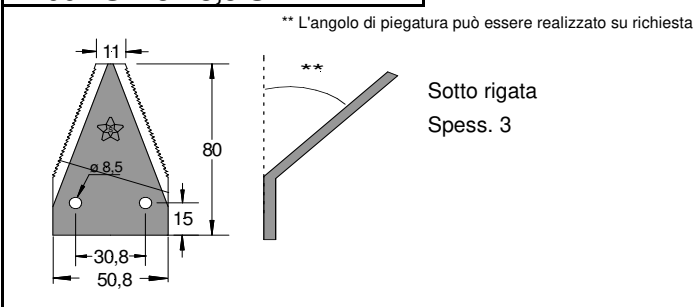

Sotto rigata
Spess. 3

89x3 L

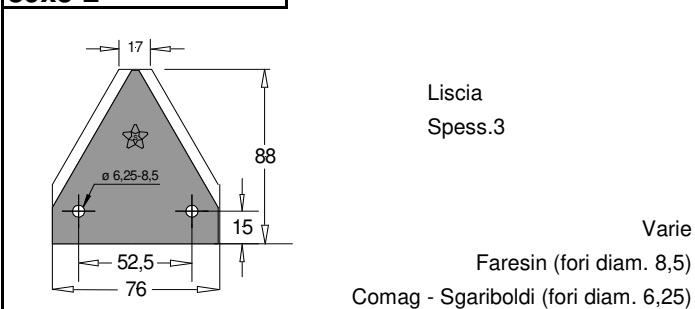

Liscia
Spess.3

Varie
Faresin (fori diam. 8,5)
Comag - Sgariboldi (fori diam. 6,25)

89x3 L P

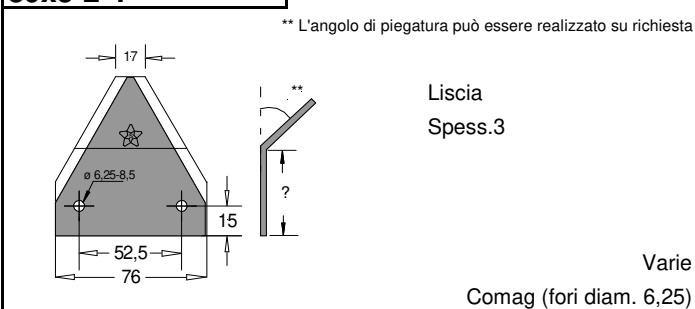

Liscia
Spess.3

Varie
Comag (fori diam. 6,25)

89x4 L

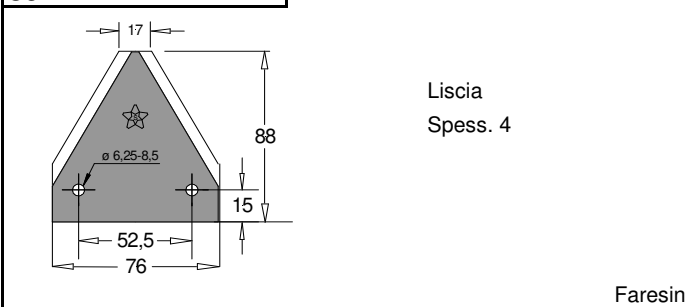

Liscia
Spess. 4

Faresin

89x4 L P

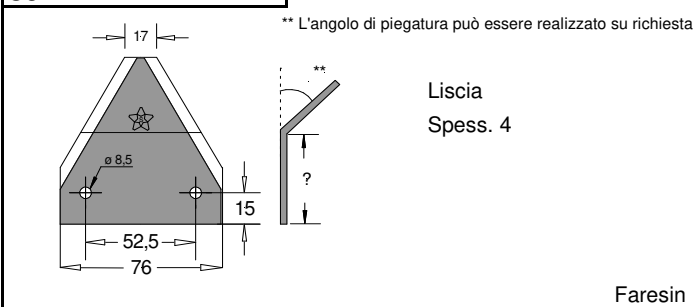

Liscia
Spess. 4

Faresin

89x3 S

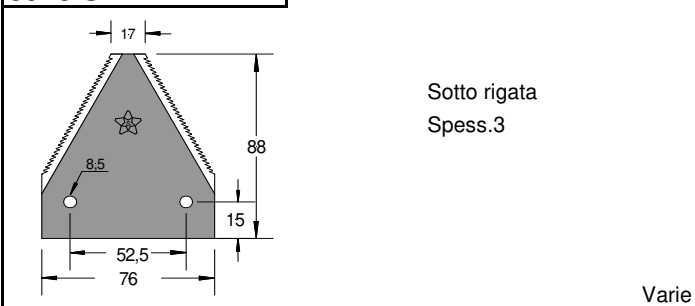

Sotto rigata
Spess.3

Varie

89x3 S P

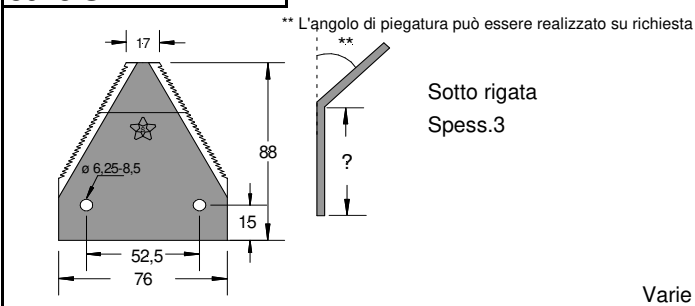

Sotto rigata
Spess.3

Varie

89x3 L f.6,25 P

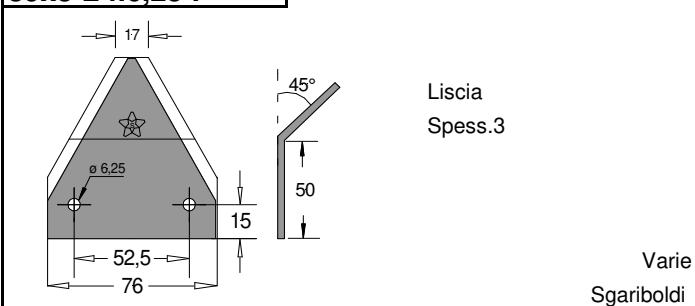

Liscia
Spess.3

Varie
Sgariboldi

89x3 L f.8,5 P

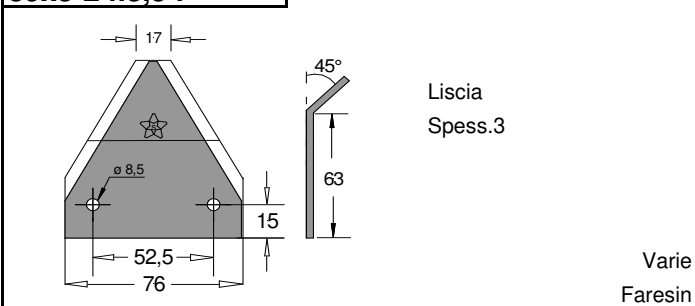

Liscia
Spess.3

Varie
Faresin



LAME PER CARRI DESILATORI - BLADES FOR SHREDDER MIXER
KLINGEN FÜR SILOSENLADER - LAMES POUR EXTRACTEUR MELANGEURS
CUCHILLAS DESMENUZADORAS PARA CARROS MEZCLADORES
НОЖИ ДЛЯ МИКСЕРОВ-КОРМОРАЗДАТЧИКОВ

Codice

Adattabili a:

Codice

Adattabili a:

89x3 L f.10,5 P 22

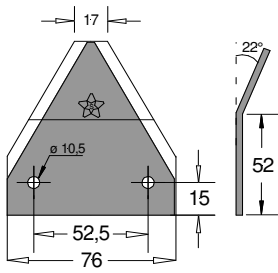

Liscia
Spess.3

Varie

89x3 L f.10,5 P 34

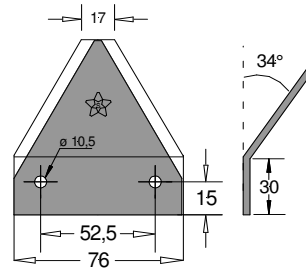

Liscia
Spess.3

Varie

89x3 L Dx - Sx

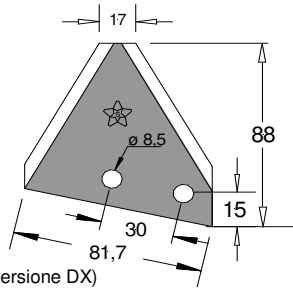

Liscia
Spess. 3 / 4

AGM
Unifast

D2001L FUX

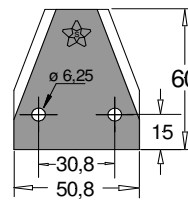

Liscia
Spess.2,5

AGM

212x3 L f.8,5

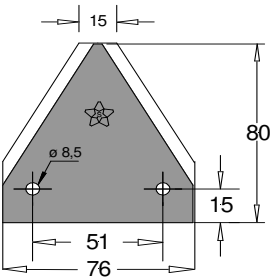

Liscia
Spess.3

212x3 L f.8,5 pieg.

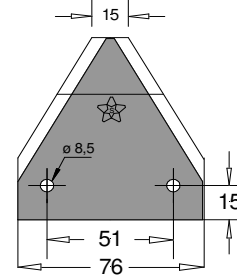

** L'angolo di piegatura può essere realizzato su richiesta

Liscia
Spess.3

212x3 L f.6,5

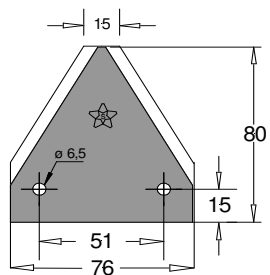

Liscia
Spess. 3

Kuhn A7153002
Varie

212x3 L f.6,5 pieg.

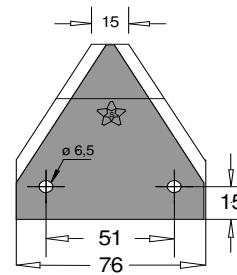

** L'angolo di piegatura può essere realizzato su richiesta.

Liscia
Spess. 3

Kuhn A7153001
Varie

363

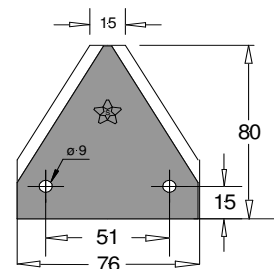

Liscia
Spess. 3

Marmix

362

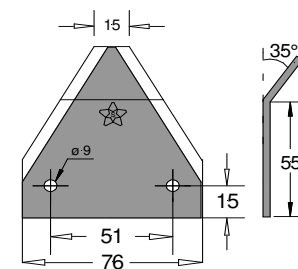

Liscia
Spess. 3

Marmix



LAME PER CARRI DESILATORI - BLADES FOR SHREDDER MIXER
KLINGEN FÜR SILOSENLADER - LAMES POUR EXTRACTEUR MELANGEURS
CUCHILLAS DESMENUZADORAS PARA CARROS MEZCLADORES
НОЖИ ДЛЯ МИКСЕРОВ-КОРМОРАЗДАТЧИКОВ

Codice

Adattabili a:

Codice

Adattabili a:

242 P dx - sx

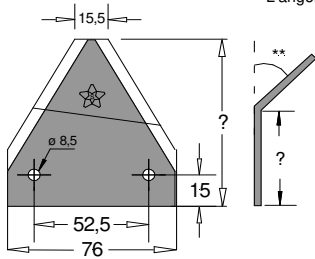

** L'angolo di piegatura può essere realizzato su richiesta

Liscia / sotto rigata
Spess.3

Seko 24479055 DX
Seko 24479056 SX
Seko 24479056 (pieg. punta)

ROTOMIX SR

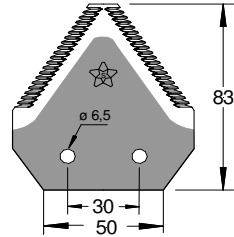

Sopra rigata
Spess. 2,7

Rotomix

ST 3001

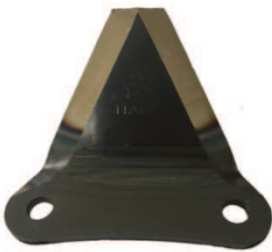

Liscia
Spess.4

NEW

Storti 16800150
Storti 1680003001 (con riporto)

ROTOMIX S

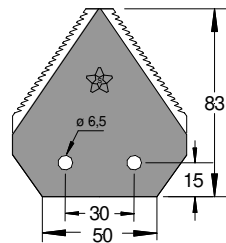

Sotto rigata
Spess. 2,7

Kuhn A7153021

ST 0029 TN

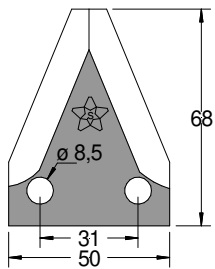

NEW

Storti 16800029

ST 0129 TN

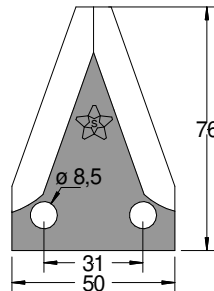

NEW

Storti 16800129

ST 7153021

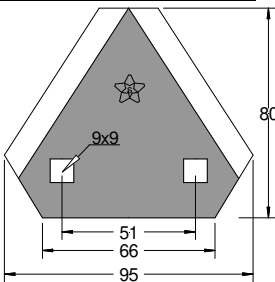

Liscia
Spess.4

NEW

Kuhn A7153021

ST604206 P60° TN

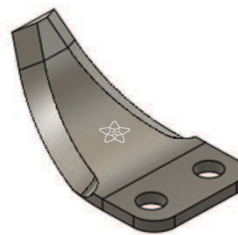

NEW

Siloking 604206

ST 704229



NEW

Silage excluding

Keenan 704229

ST 1350 TN

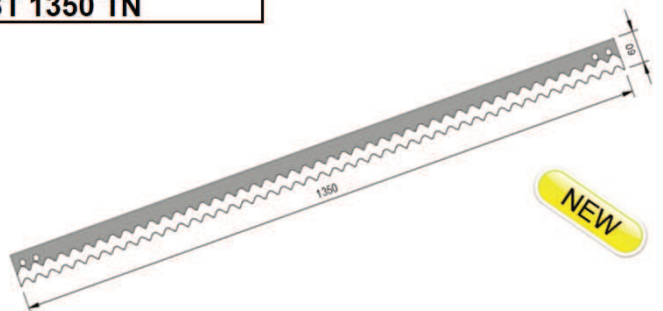

NEW

Guaresi 19078



LAME PER CARRI DESILATORI - BLADES FOR SHREDDER MIXER
KLINGEN FÜR SILOSENLADER - LAMES POUR EXTRACTEUR MELANGEURS
CUCHILLAS DESMENUZADORAS PARA CARROS MEZCLADORES
НОЖИ ДЛЯ МИКСЕРОВ-КОРМОРАЗДАТЧИКОВ

Codice

Adattabili a:

Codice

Adattabili a:

DISCO 95

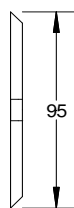

Spess. 5
 Foro 11 x 11 Sgariboldi
 Himel 3001689
 Pagliari - Marmix
 Luclar - Eurocomp
 Supertino - Tatoma
 Storti 1680020
 Frasto 16800020 - Walker
 DeLaval 94832401

DISCO DENTATO 95



Spess. 5
 Foro 11 x 11
 Himel
 Tatoma
 Storti 16800014
 Frasto 16800014 - Walker
 Kverneland

DISCO DENTATO SK

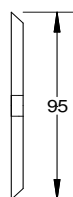
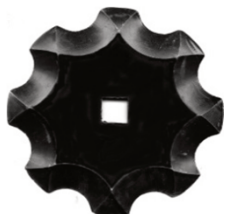

Spess. 5
 Foro 11 x 11

DISCO DENTATO SK - diam.140

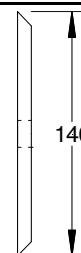
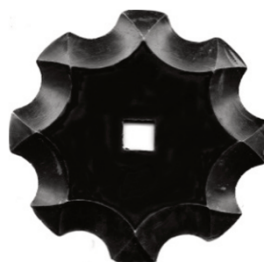

Spess. 8
 Foro 16,5 x 16,5

COLTELLO OVALE DENTATO



Spess. 5

Storti 16800139

DISCO MARGHERITA diam. 95



Spess. 5
 Foro 11 x 11

Varie

COLTELLO OVALE DENTATO DIAM. 110



Storti 16800171

ALETTA DX-SX

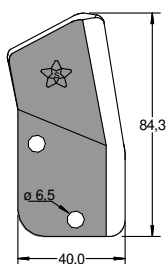

Spess. 3
 Foro Ø 6,5

(versione SX)

Storti 16800012-13

ALETTA DX-SX

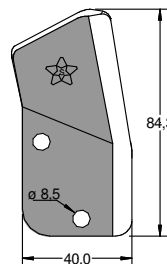

Spess. 4
 Foro Ø 8,5

(versione SX)



LAME PER CARRI DESILATORI - BLADES FOR SHREDDER MIXER
KLINGEN FÜR SILOSENLADER - LAMES POUR EXTRACTEUR MELANGEURS
CUCHILLAS DESMENUZADORAS PARA CARROS MEZCLADORES
НОЖИ ДЛЯ МИКСЕРОВ-КОРМОРАЗДАТЧИКОВ

Codice

Adattabili a:

Codice

Adattabili a:

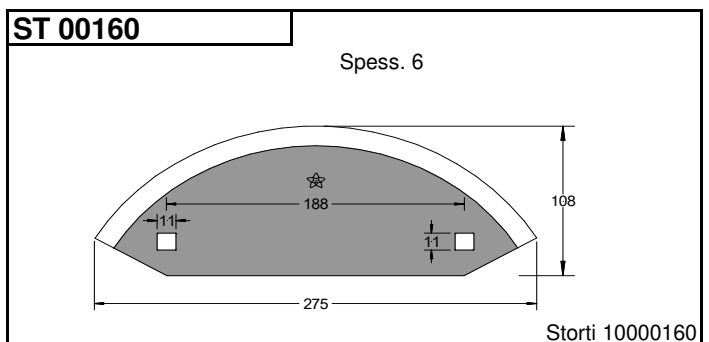
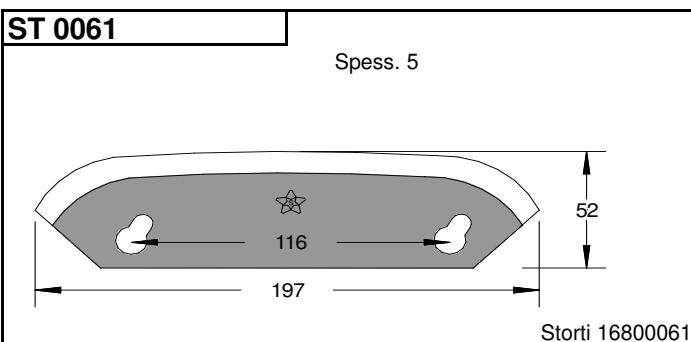
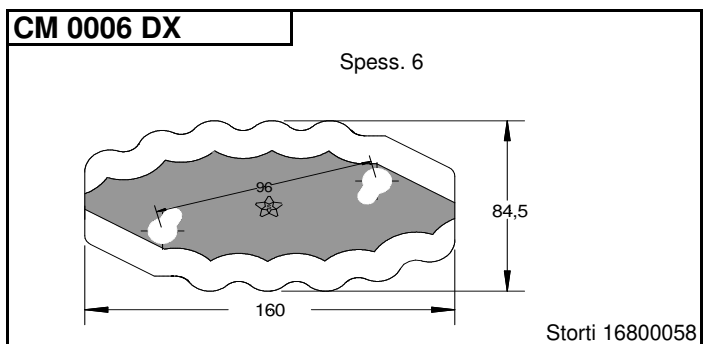
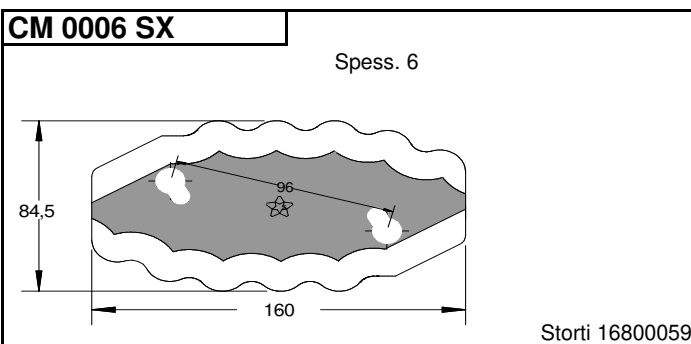
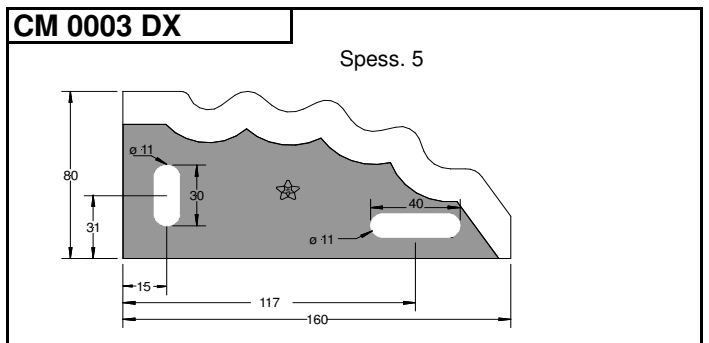
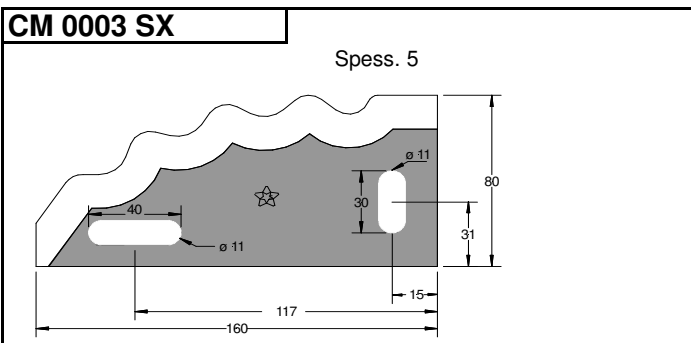
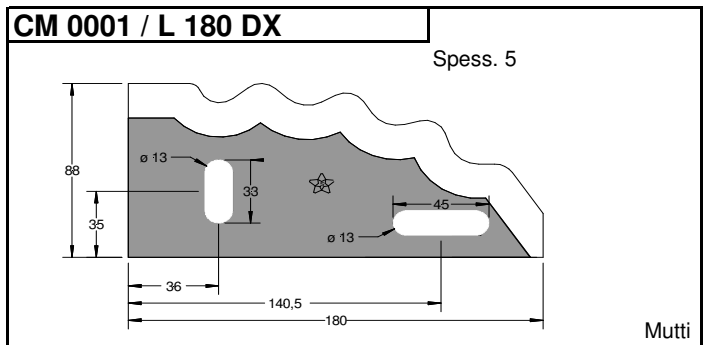
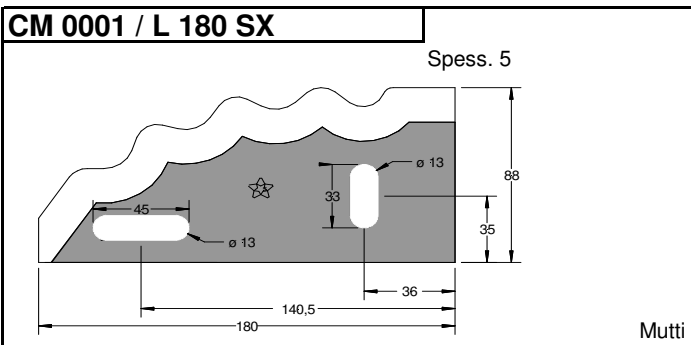
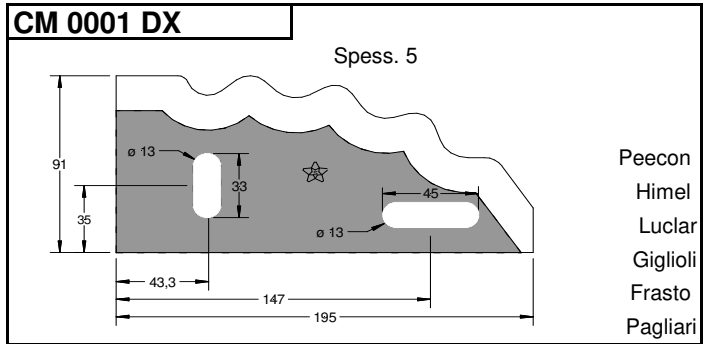
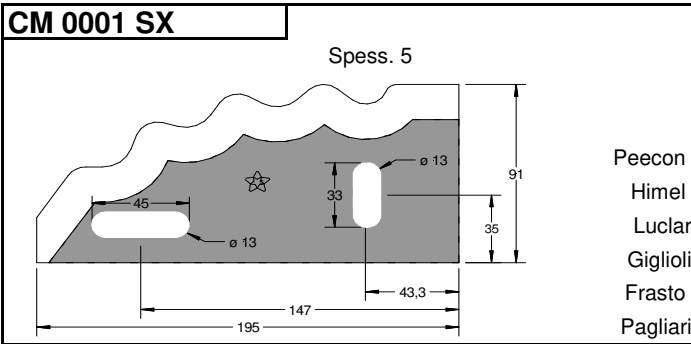

LAME PER CARRI DESILATORI - BLADES FOR SHREDDER MIXER
KLINGEN FÜR SILOSENLADER - LAMES POUR EXTRACTEUR MELANGEURS
CUCHILLAS DESMENUZADORAS PARA CARROS MEZCLADORES
НОЖИ ДЛЯ МИКСЕРОВ-КОРМОРАЗДАТЧИКОВ

Codice

Adattabili a:

Codice

Adattabili a:

ST 00133

Spess. 6

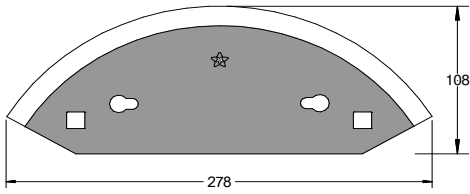

Storti 16800133

CMF 0020

Spess. 5

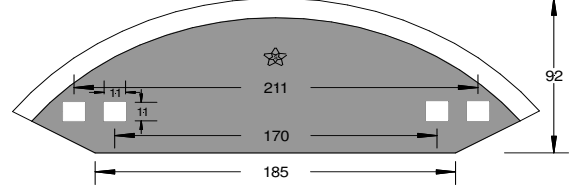

Faresin

CMF 0021 SX

Spess. 5 / 6

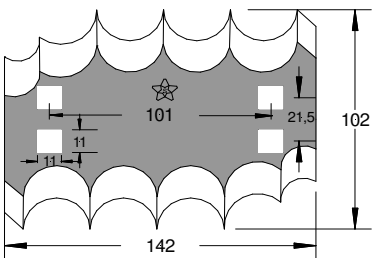

Faresin 30840.8750

CMF 0021 DX

Spess. 5 / 6

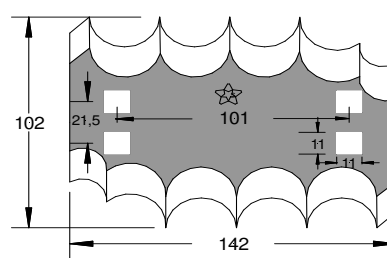

Faresin 30845.9950

CMS 0005 SX

Spess. 5

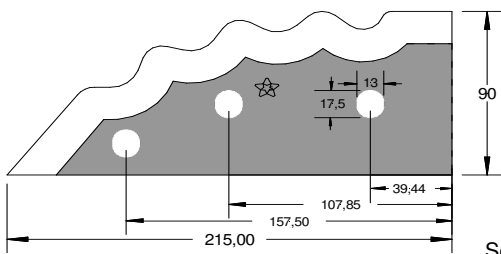

Sgariboldi CL04.008

CMS 0005 DX

Spess. 5

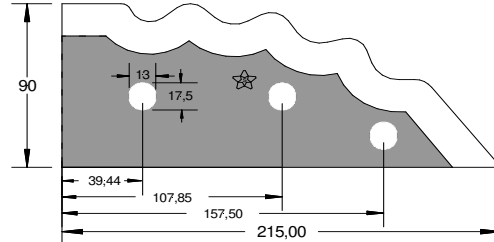

Sgariboldi CL04.014

CM 0002

Spess. 5

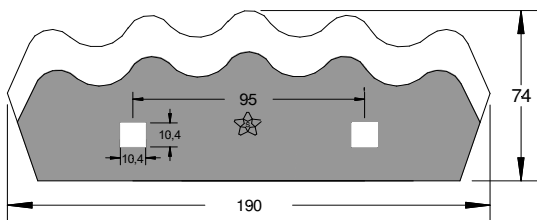

Marmix

CM 0008

Spess. 5

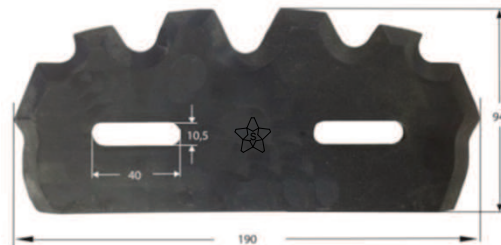

Giglioli

CM 0009 T

Spess. 5

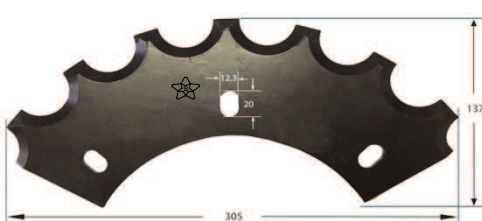

Tatoma MR-090-06

ST 703954 SX

ST 703955 DX

Spess. 5



Keenan 703955
Keenan 703954



LAME PER CARRI DESILATORI - BLADES FOR SHREDDER MIXER
KLINGEN FÜR SILOSENLADER - LAMES POUR EXTRACTEUR MELANGEURS
CUCHILLAS DESMENUZADORAS PARA CARROS MEZCLADORES
НОЖИ ДЛЯ МИКСЕРОВ-КОРМОРАЗДАТЧИКОВ

Codice

Adattabili a:

Codice

Adattabili a:

ST 703956 SX

ST 703957 DX

ST 701359 SX

ST 701358 DX



RRC 210x220

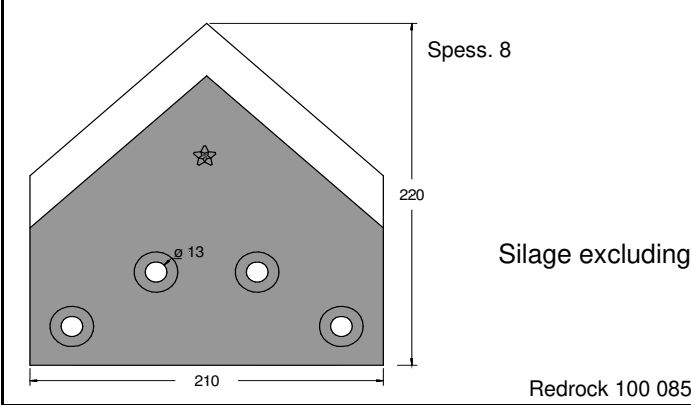

RRS 160x220

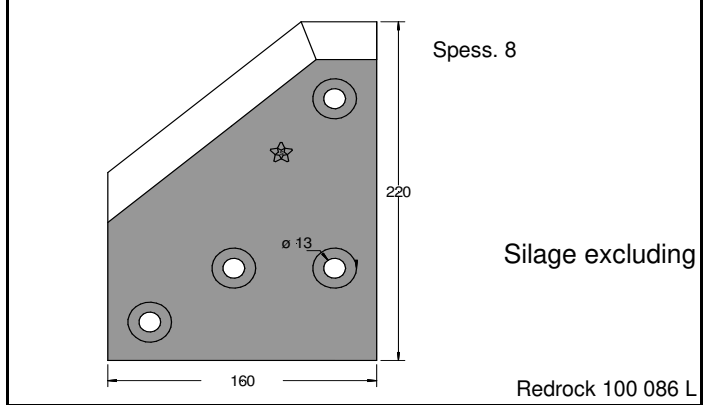

RRD 160x220

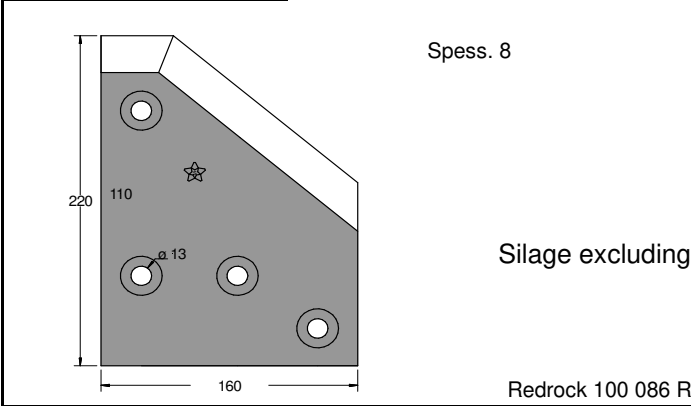

COLTELLO TR



ST 7153012

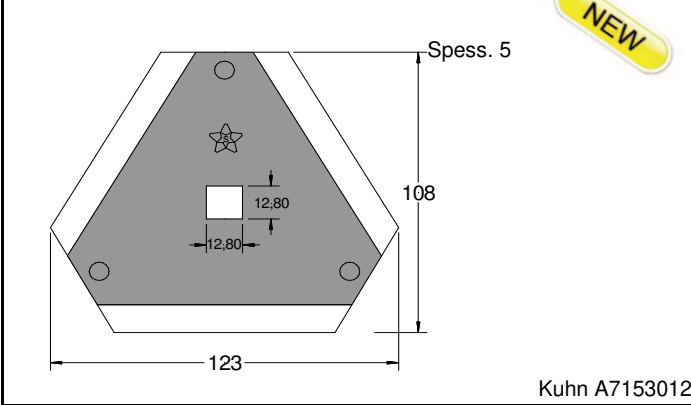

ST 5306460

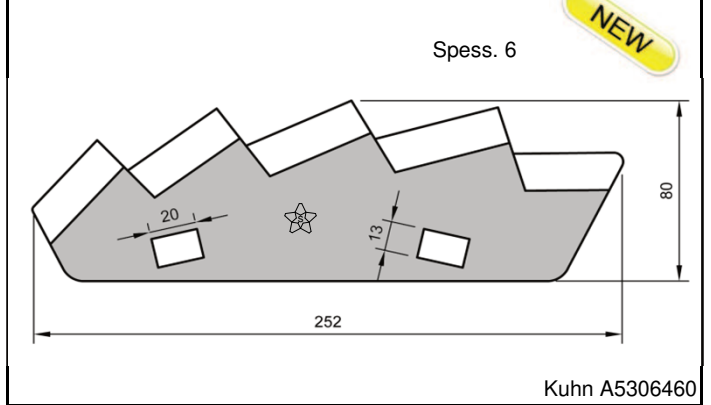

LAME PER CARRI DESILATORI - BLADES FOR SHREDDER MIXER
KLINGEN FÜR SILOSENLADER - LAMES POUR EXTRACTEUR MELANGEURS
CUCHILLAS DESMENUZADORAS PARA CARROS MEZCLADORES
НОЖИ ДЛЯ МИКСЕРОВ-КОРМОРАЗДАТЧИКОВ

Codice

Adattabili a:

Codice

Adattabili a:

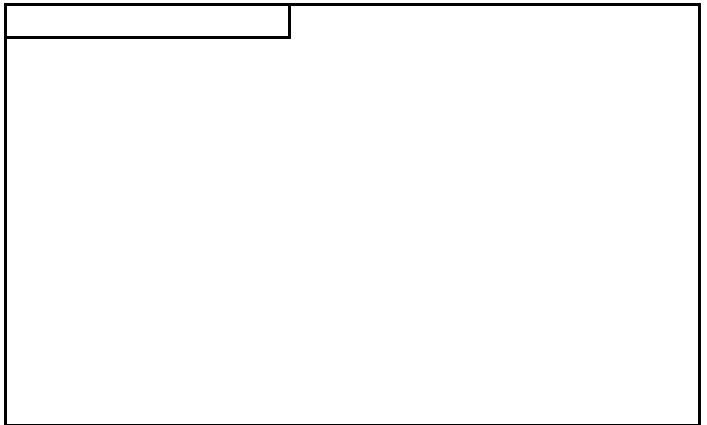
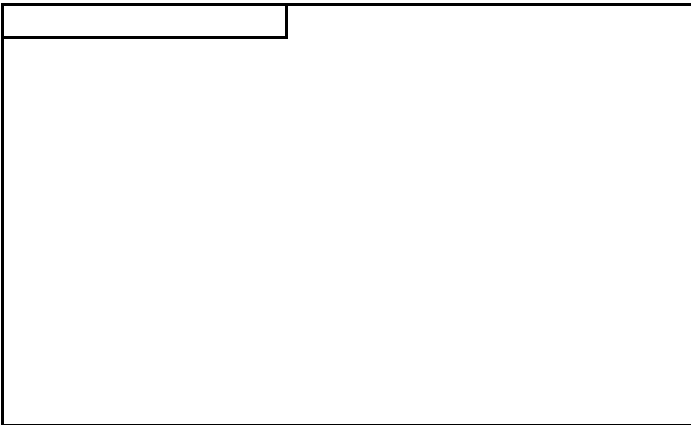
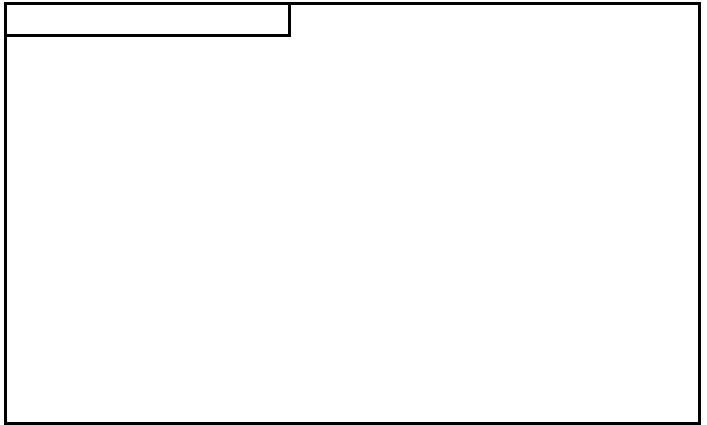
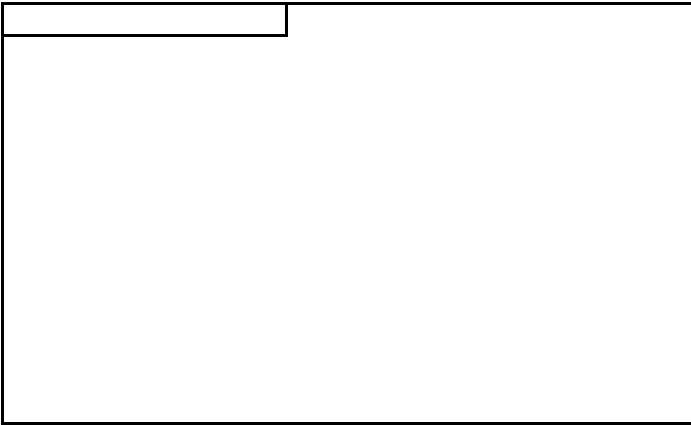
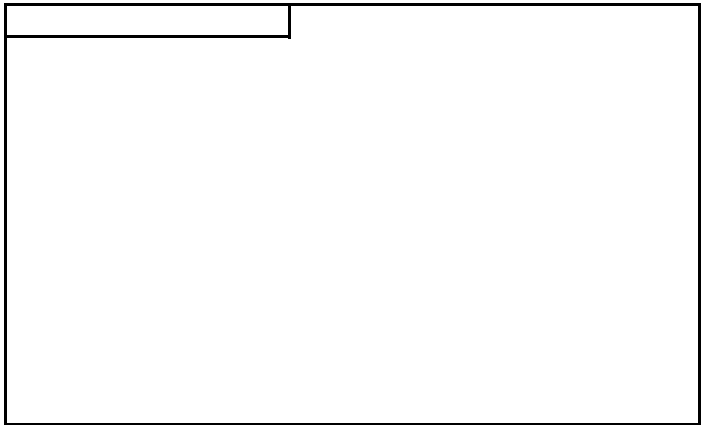
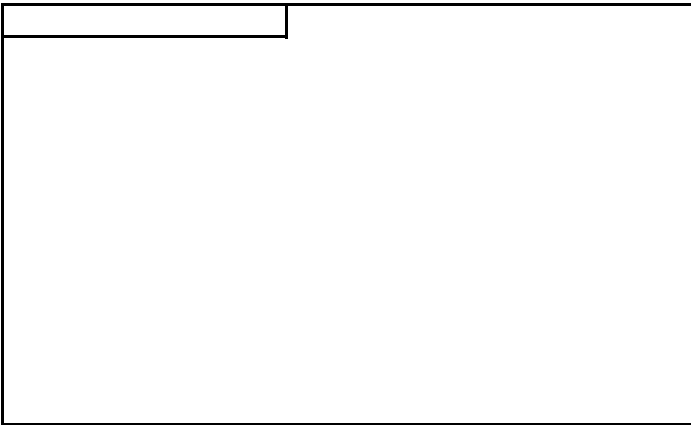
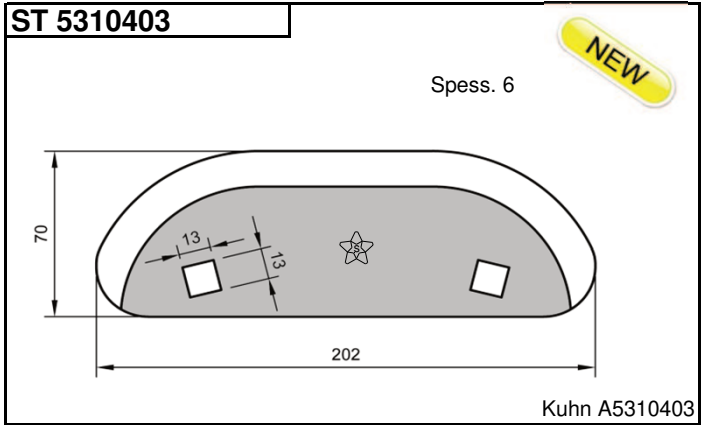
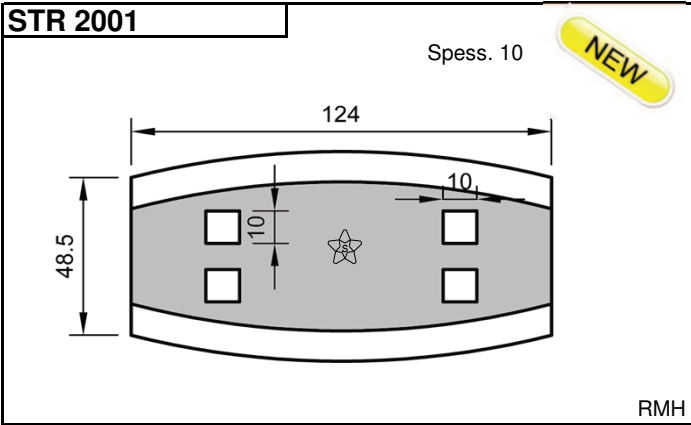

LAME PER CARRI DESILATORI - BLADES FOR SHREDDER MIXER
KLINGEN FÜR SILOSENLADER - LAMES POUR EXTRACTEUR MELANGEURS
CUCHILLAS DESMENUZADORAS PARA CARROS MEZCLADORES
НОЖИ ДЛЯ МИКСЕРОВ-КОРМОРАЗДАТЧИКОВ

Codice

Adattabili a:

Codice

Adattabili a:

CMV 0004 - Platinum

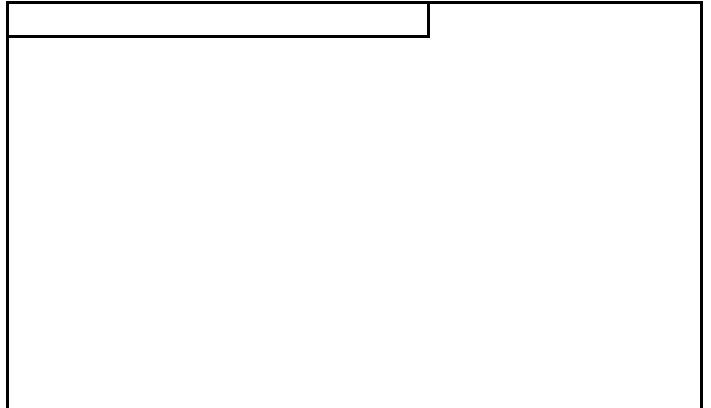
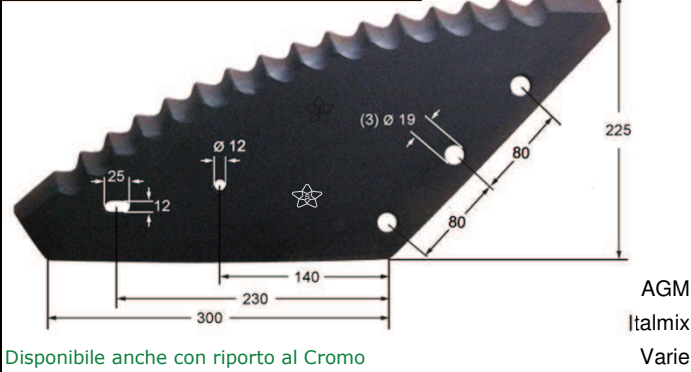

CMV 0007 SX - Standard

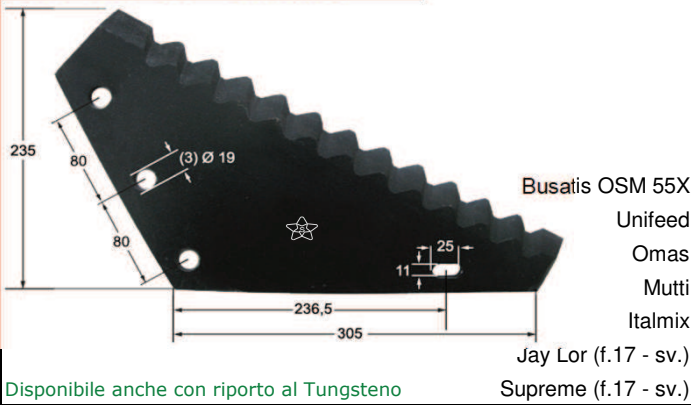

CMV 0007 DX - Standard

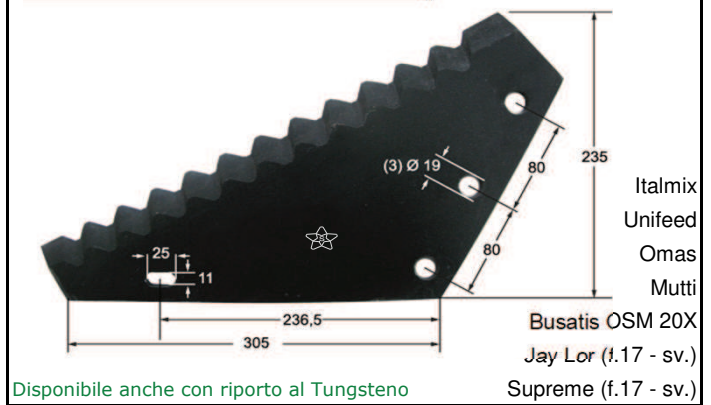

CMV 0007 SX - Platinum

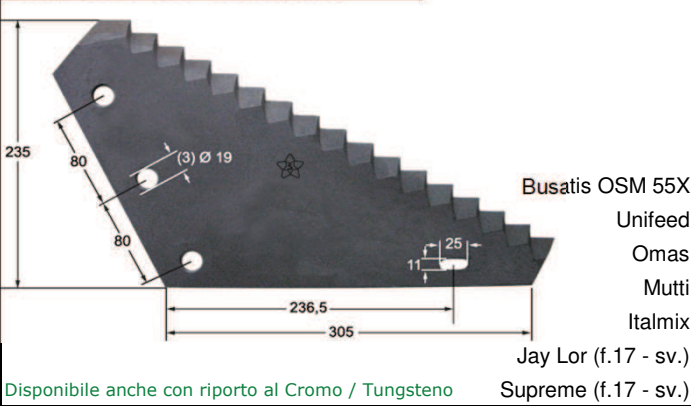

CMV 0007 DX - Platinum

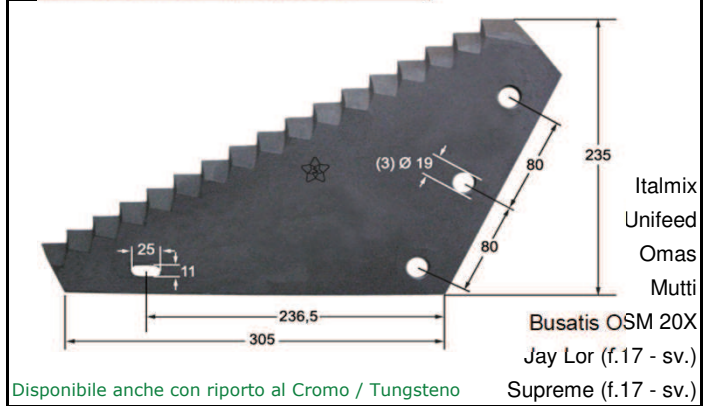

CMV 0009 SX - Standard

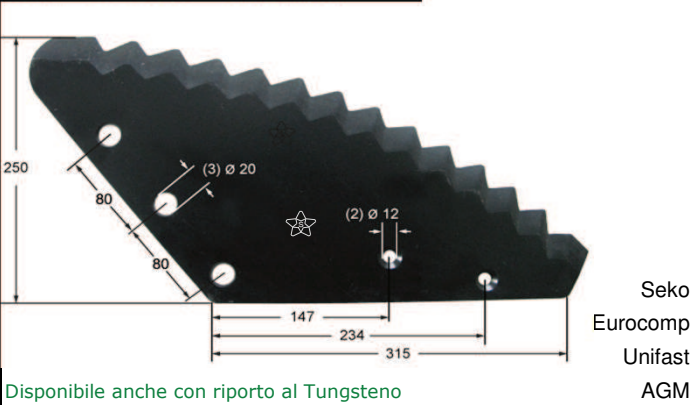

CMV 0009 DX - Standard

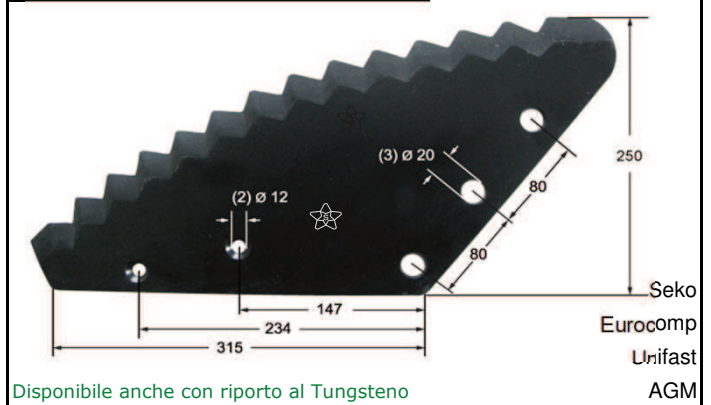

LAME PER CARRI DESILATORI - BLADES FOR SHREDDER MIXER
KLINGEN FÜR SILOSENLADER - LAMES POUR EXTRACTEUR MELANGEURS
CUCHILLAS DESMENUZADORAS PARA CARROS MEZCLADORES
НОЖИ ДЛЯ МИКСЕРОВ-КОРМОРАЗДАТЧИКОВ

Codice

Adattabili a:

Codice

Adattabili a:

CMV 0009 SX - Platinum

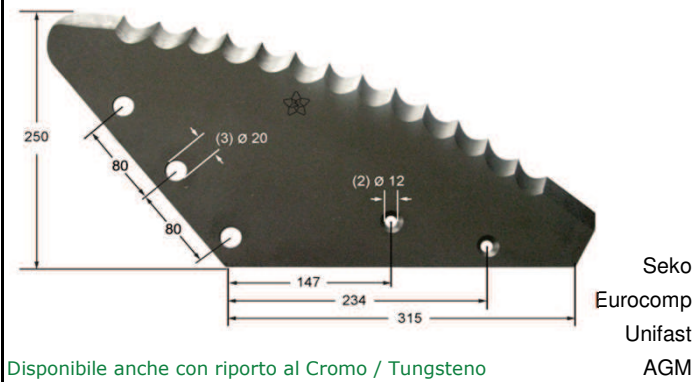

CMV 0009 DX - Platinum

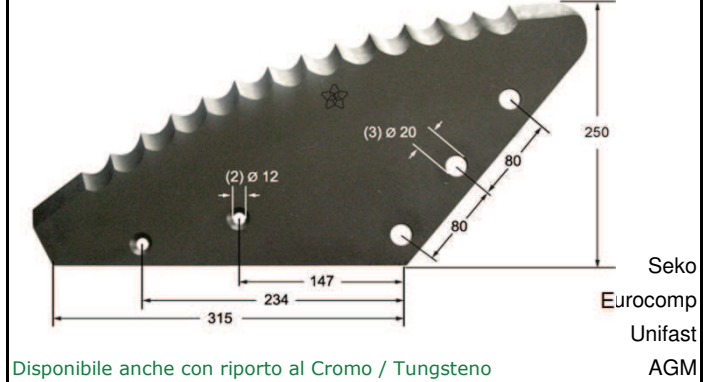

CMV 0010 SX - Standard

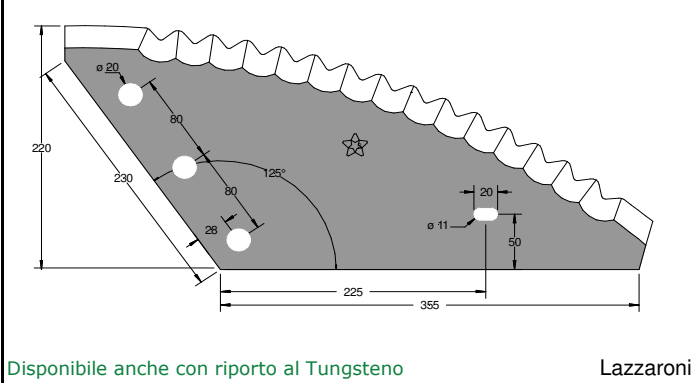

CMV 0010 DX - Standard

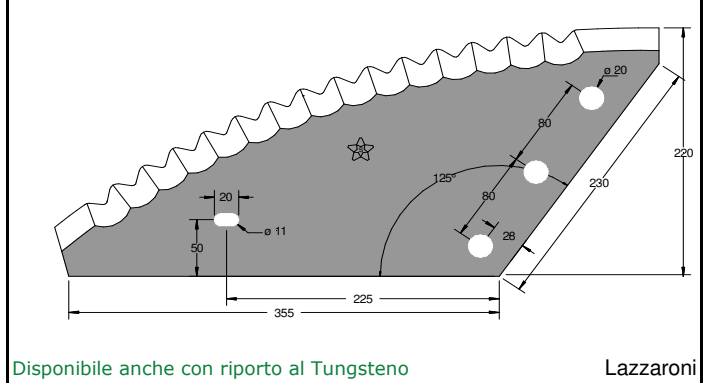

CMV 0011 SX - Platinum

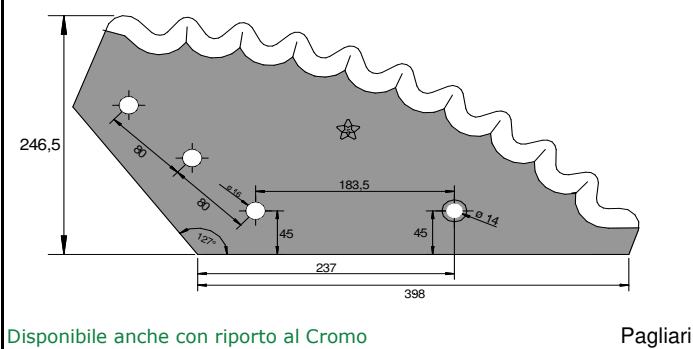

CMV 0011 DX - Platinum

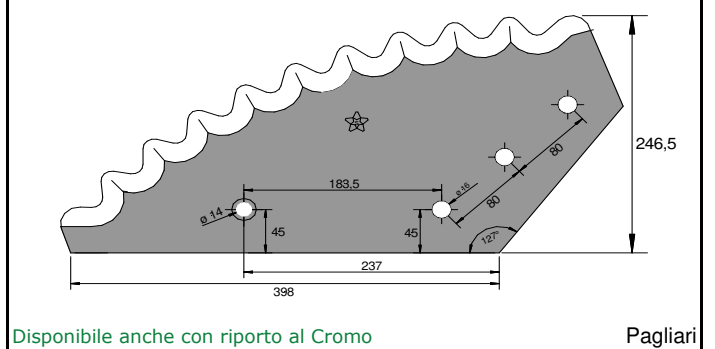

CMV 0012 - Platinum

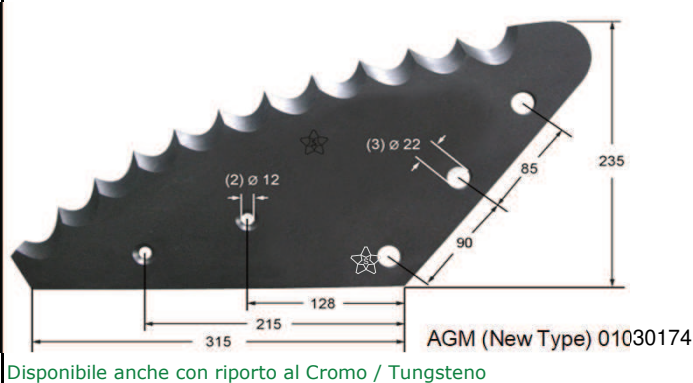

CMV 0015

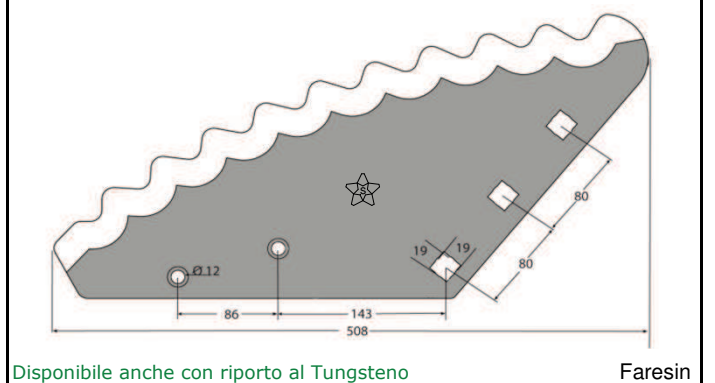

LAME PER CARRI DESILATORI - BLADES FOR SHREDDER MIXER
KLINGEN FÜR SILOSENLADER - LAMES POUR EXTRACTEUR MELANGEURS
CUCHILLAS DESMENUZADORAS PARA CARROS MEZCLADORES
НОЖИ ДЛЯ МИКСЕРОВ-КОРМОРАЗДАТЧИКОВ

Codice

Adattabili a:

Codice

Adattabili a:

CMV 0014 SX - Standard



Disponibile anche con riporto al Tungsteno

Supertino

CMV 0014 DX - Standard



Disponibile anche con riporto al Tungsteno

Supertino

CMV 0016

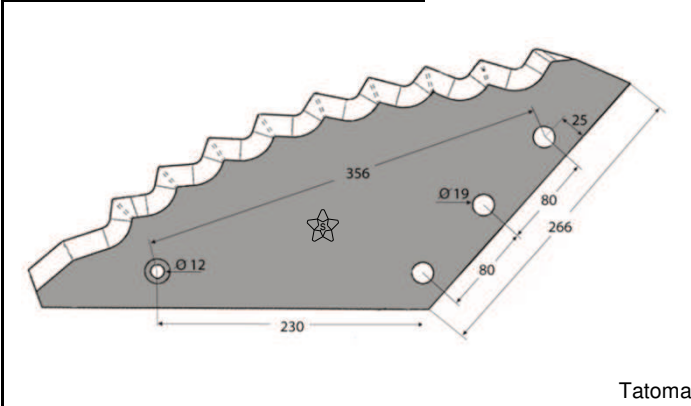

Tatoma

CMV 0018

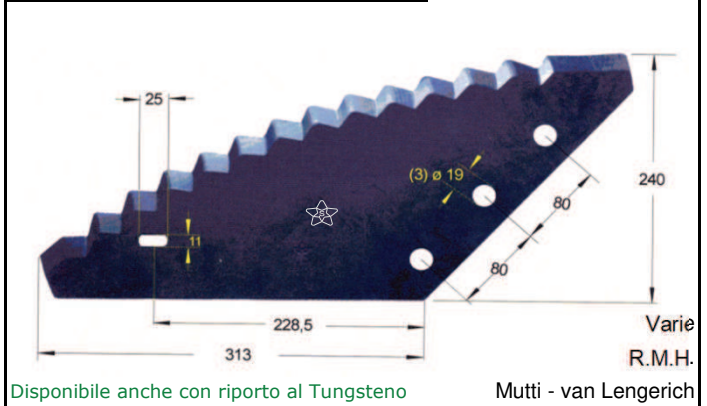

Disponibile anche con riporto al Tungsteno

Varie R.M.H. Mutti - van Lengerich

CMV 0019

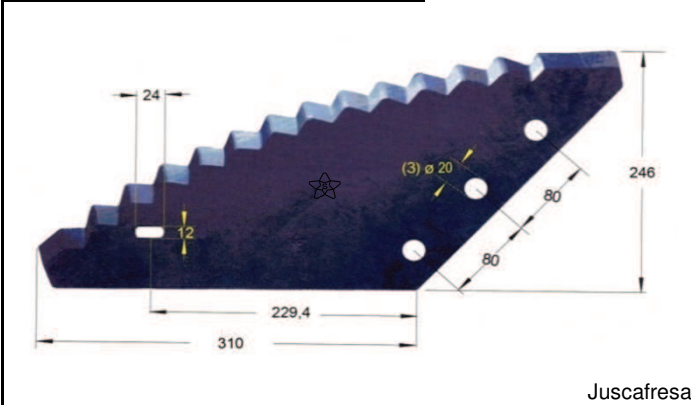

Juscafresa

CMV 0020

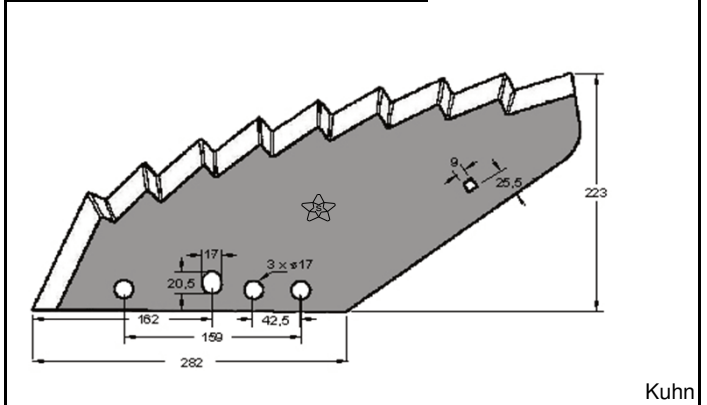

Kuhn

CMV 0021

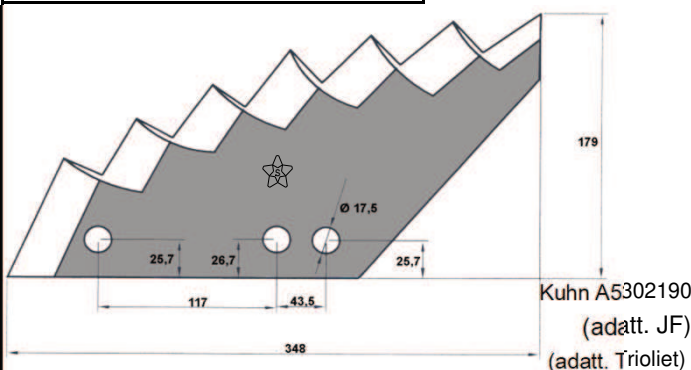

Kuhn A5302190
(adatt. JF)
(adatt. Trioliet)

CMV 0022

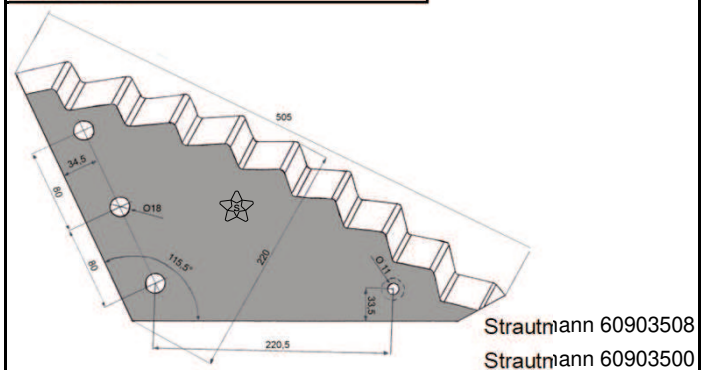

Strautmann 60903508
Strautmann 60903500



LAME PER CARRI DESILATORI - BLADES FOR SHREDDER MIXER
KLINGEN FÜR SILOSENLADER - LAMES POUR EXTRACTEUR MELANGEURS
CUCHILLAS DESMENUZADORAS PARA CARROS MEZCLADORES
НОЖИ ДЛЯ МИКСЕРОВ-КОРМОРАЗДАТЧИКОВ

Codice

Adattabili a:

Codice

Adattabili a:

CMV 0023

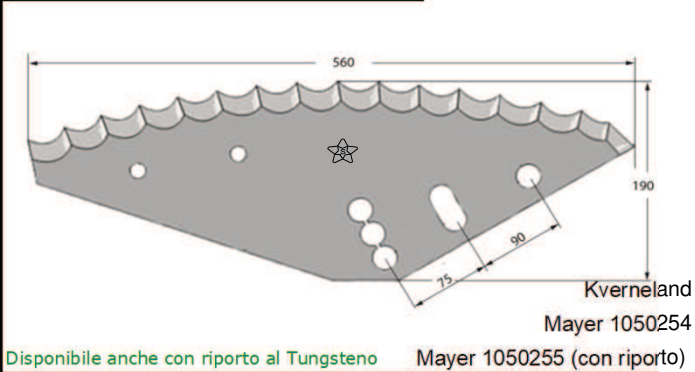

Disponibile anche con riporto al Tungsteno Mayer 1050255 (con riporto)

CMV 0023 JEANTIL

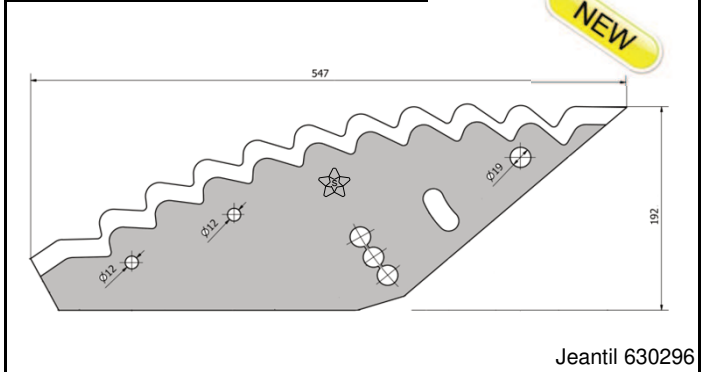

Jeantil 630296

CMV 0024

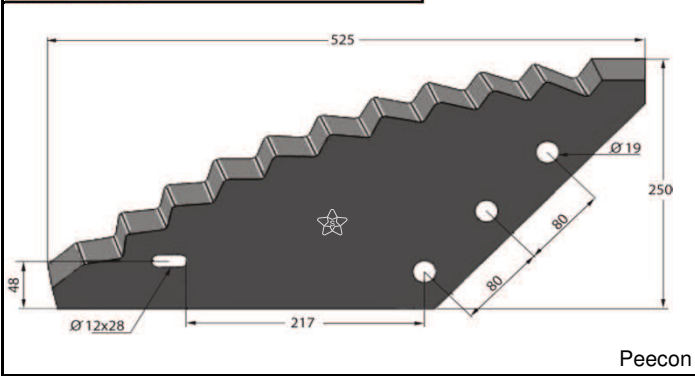

Peecon

CMV 0025 TN

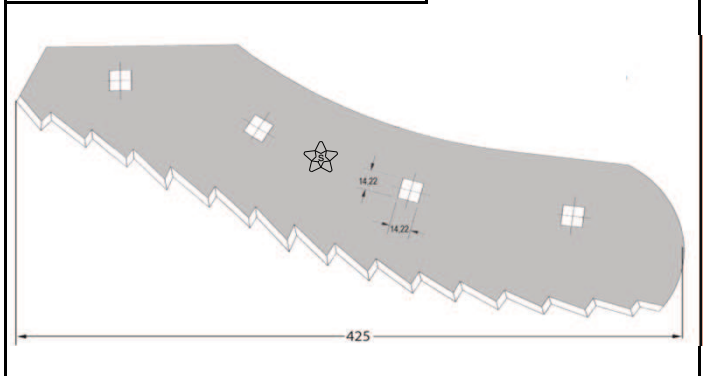

Con riporto al Tungsteno

Jay Lor

CMV 0026 TN

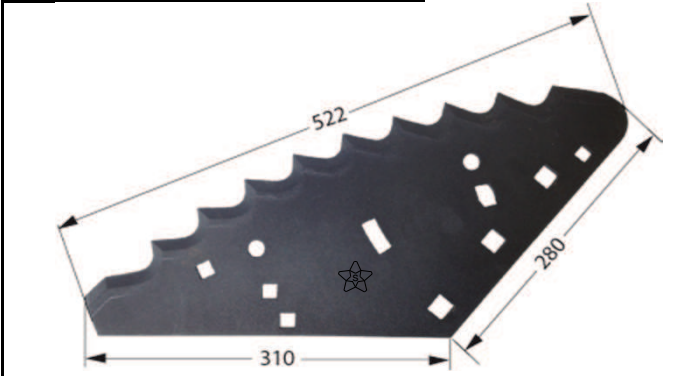

Con riporto al Tungsteno

Penta

CMV 0027

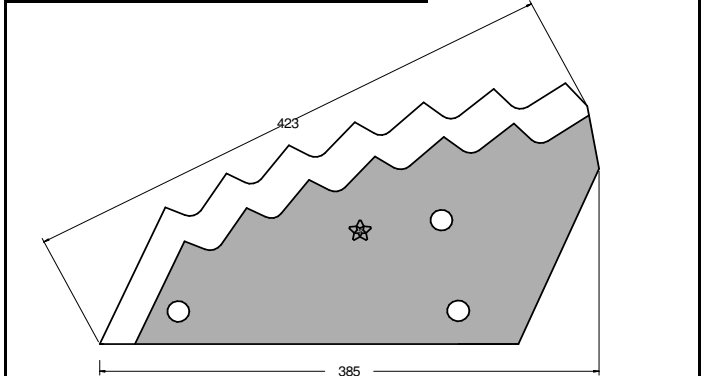

Kuhn 006-70147065

CMV 0028

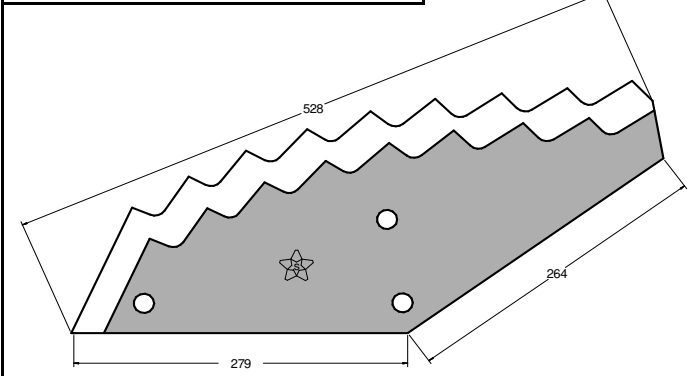

Kuhn 023-70144734

CMV 0029

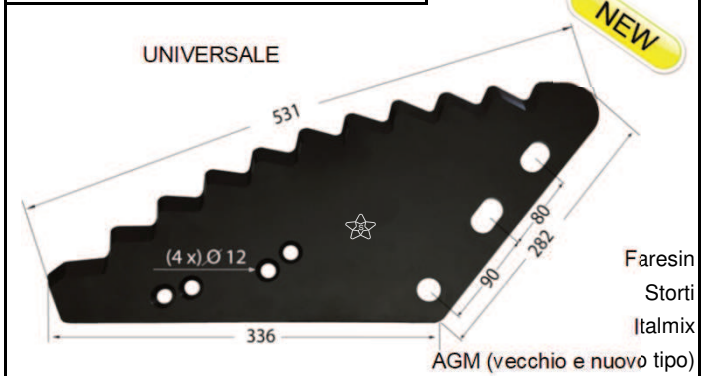

Disponibile anche con riporto al Cromo / Tungsteno

General Mix



LAME PER CARRI DESILATORI - BLADES FOR SHREDDER MIXER
KLINGEN FÜR SILOSENLADER - LAMES POUR EXTRACTEUR MELANGEURS
CUCHILLAS DESMENUZADORAS PARA CARROS MEZCLADORES
НОЖИ ДЛЯ МИКСЕРОВ-КОРМОРАЗДАТЧИКОВ

Codice

Adattabili a:

Codice

Adattabili a:

CMV 00155

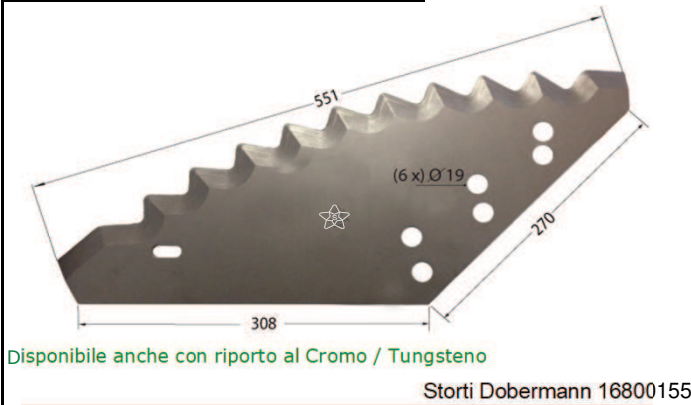

ST 16200



CMV 0035

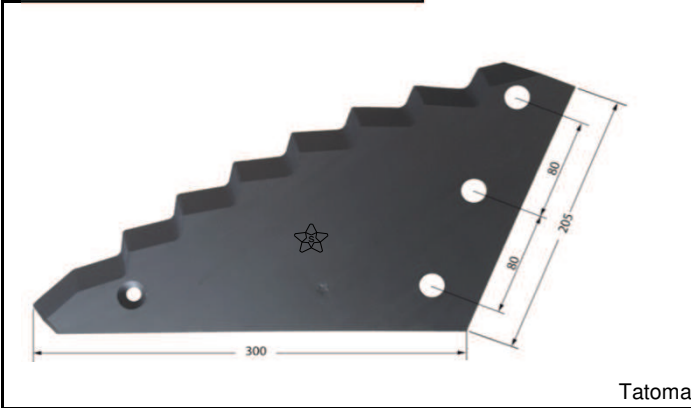

CMV 0046 TN

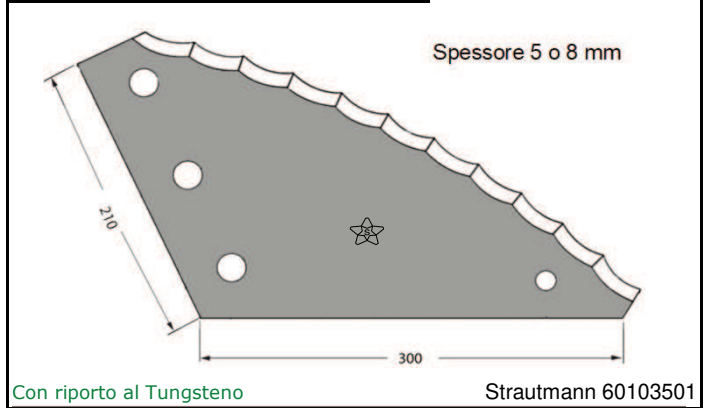

CMV 0047

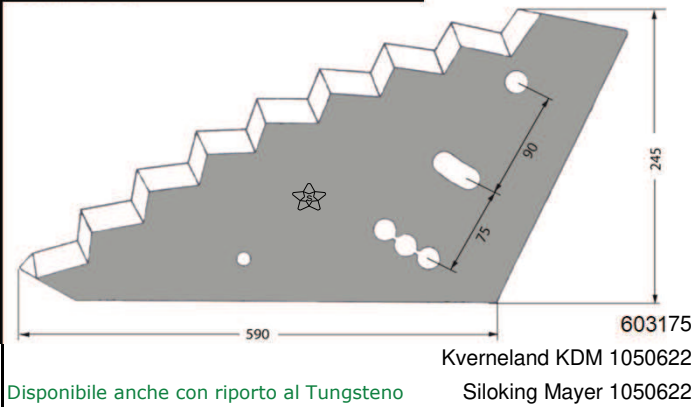

CMV 0030

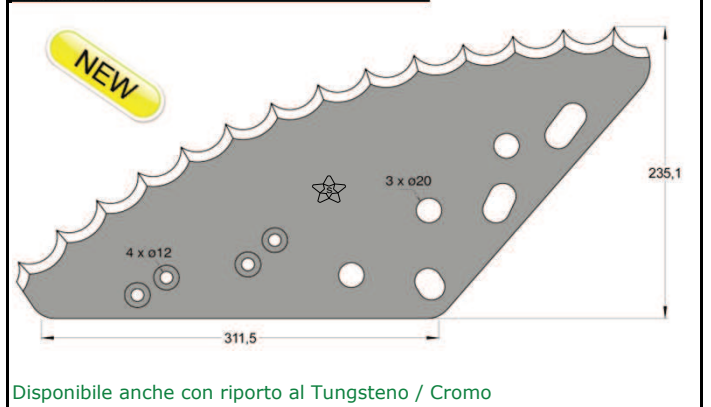

CMV 0048

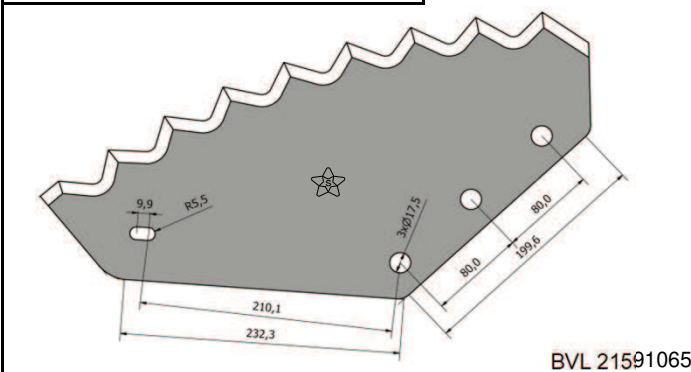

ST 05945



ST 05818



LAME PER CARRI DESILATORI - BLADES FOR SHREDDER MIXER
KLINGEN FÜR SILOSENLADER - LAMES POUR EXTRACTEUR MELANGEURS
CUCHILLAS DESMENUZADORAS PARA CARROS MEZCLADORES
НОЖИ ДЛЯ МИКСЕРОВ-КОРМОРАЗДАТЧИКОВ

Codice

Adattabili a:

Codice

Adattabili a:

CMV 0057

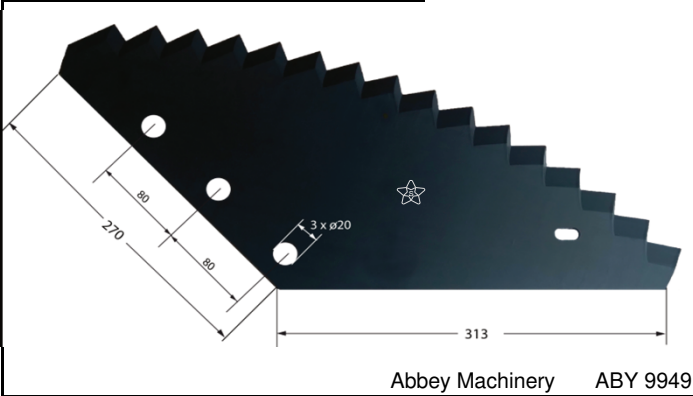

CMV 0049

