



CATALOGO PRODOTTI 2021



STORIA DI UN MARCHIO, REALTA' DI UN PRODOTTO

- 1948** Le Acciaierie e Ferriere Lombarde Falck, leader italiano nella produzione dei nastri d'acciaio legato e ad alto carbonio, nell'ambito di un processo di verticalizzazione danno vita ad una realtà produttiva che si caratterizza per la fabbricazione di sezioni di lama destinate alle macchine falciatrici e mietitrebbia.
Nasce il marchio STELLA.
Le lame STELLA in breve tempo acquistano notorietà diventando sul mercato italiano sinonimo di qualità.
- 1995** La nuova proprietà guidata dall'Ing. Alfredo Tricomi rileva il ramo d'azienda e avvia un programma di potenziamento delle linee produttive e della gamma prodotti.
Inizia la crescita internazionale di Stella.
- 1996** STELLA viene trasferita nell'attuale Headquarter di Cellatica, alle porte di Brescia, Italia.
- 2008** I sistemi di taglio Stella festeggiano i loro primi 60 anni sul mercato.
- 2021** STELLA, leader in Italia, continua la sua espansione sui principali mercati internazionali grazie all'ampliamento della gamma prodotti e al costante orientamento alla qualità totale.

Lame Stella - 70 anni di qualità totale



INDICE PRODOTTI

Sezioni di lame falciatrici	01
Sezioni di lame mietitrebbia	07
Lame per viticoltura e per cimatrici.....	13
Lame per biotrituratori	17
Coltelli per falciatrici rotative	19
Viti, dadi e bulloni	31
Coltelli trinciapaglia & boccole	33
Coltelli trinciastocchi / Coltelli testata mais	43
Coltelli per canna da zucchero	49
Lame per carri desilatori	51
Coltelli per rotopresse / autocaricanti.....	65
Piastrine di pulizia	77
Lame per decespugliatori	79
Kit lame per robot automatici	81
Lame complete Stella per falciatrici	83
Lame complete Stella per mietitrebbia	87
Denti per mietitrebbia e falciatrici.....	91
Lame speciali	



LEGENDA



- L** liscia naturale
- LL** liscia spianata
- S** sotto rigata
- SR** sopra rigata
- F** con finestra
- SV** svasatura fori sopra
- SVS** svasatura fori sotto
- CR** cromatura
- P** piegata
- Zn** zincata

Le misure sulle lame sono espresse in millimetri



- L** Klinge glatt
- LL** Klinge glatt abgeschrägt
- S** Klinge u. gezahnt
- SR** Klinge o. gezahnt
- F** Mit Schlitzloch
- SV** Klinge oben versenkt
- SVS** Klinge unten versenkt
- CR** Verchromt
- P** Gefaltet
- Zn** Verzinkung

Die Maße der Klingen sind in millimeters



- L** liso natural
- LL** liso
- S** bajo dentada
- SR** superior dentada
- F** con la apertura
- SV** agujeros hasta avellanado
- SVS** agujeros por avellanado
- CR** cromado
- P** doblado
- Zn** galvanizado

Las medidas indicadas en las hojas están en milímetros



- L** regular
- LL** smooth
- S** under serrated
- SR** top serrated
- F** with opening
- SV** holes up countersink
- SVS** holes down countersink
- CR** chrome plated
- P** bendet
- Zn** galvanized

The measures on the blade are in millimeters



- L** section lisse
- LL** lisse nivelée
- S** fauc. dessous
- SR** fauc. dessus
- F** avec fenetre
- SV** trous fraisés dessus
- SVS** trous fraisés dessous
- CR** chromate
- P** plié
- Zn** zingueè

Les mesures sur les lamas son en millimètres

Le lame del presente catalogo sono adattabili alle marche indicate. I codici e le marche sono solo specificate per fini comparativi e di adattabilità.

SEZIONI DI LAME FALCIATRICI

www.stellalame.com



SEZIONI DI LAME FALCIATRICI - MOWERS BLADES
KLINGEN FÜR MAHMASCHINEN - SECTIONS FAUCHEUSES
SECCIONES CUCHILLAS MOTOSEGADORAS - СЕГМЕНТЫ ДЛЯ КОСИЛОК

Codice

Adattabili a:

Codice

Adattabili a:

212 S

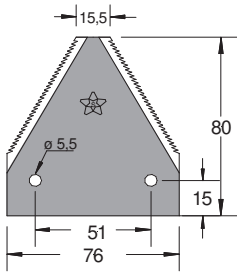

Sotto rigata
Spess. 2 / 3

436 / 436 G / 436 Plain
Valpadana
D.4010
John Deere Z7029H
John Deere Z7030 H (sp.3)

212 SF

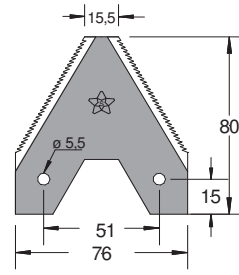

Sotto rigata
Spess. 2

Sep
Bcs 580 02466
Bertolini 2091/582091
Grillo 10642
Nibbi 4229
Losi / Barbieri
Bcs 580 29866

212 SF - h.75 sv.

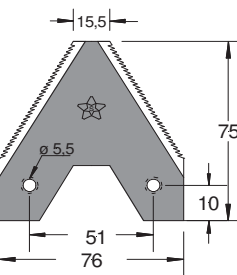

Sotto rigata
Spess. 2
Svas. sotto

Bcs 580 27785

212 SF sp.3

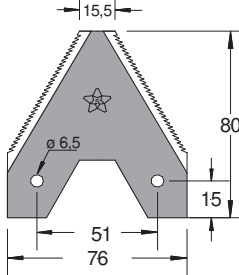

Sotto rigata
Spess. 3

Seko
Seko 24479005 (pieg.)
Bertolini
Bcs 2466/3
Bedogni 12198
Sep 206775
Nibbi NB4249

242 S

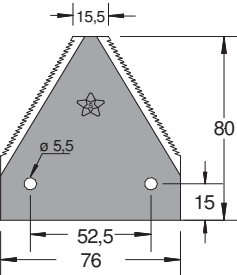

Sotto rigata
Spess. 2

Gaspardo 443024 - 420016
Rasspe ME333-MB333
Laverda 340443003
Gribaldi & Salvia 902
(Liscia) Laverda 340443002
(Liscia) Gribaldi & Salvia 901
(sp.3) Rasspe M22831

88x3 S f. 6,25 sv.

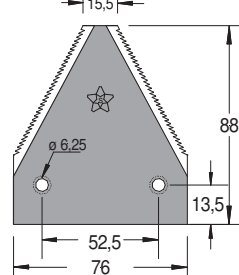

Sotto rigata
Spess. 3
Svas. sotto

Applicazione FB 940
Gaspardo 21120243
Gaspardo 3012370
Enorossi 12880853

88x3 S f. 5,5 sv.

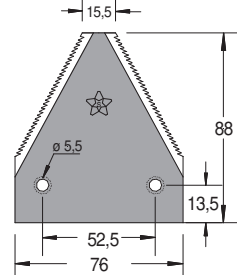

Sotto rigata
Spess. 3
Svas. sotto

Applicazione FB 925
Gaspardo 21120065
Gaspardo 158123UV
(Non svas.) Gaspardo 3010030

89x3 S f. 5,5 sv.

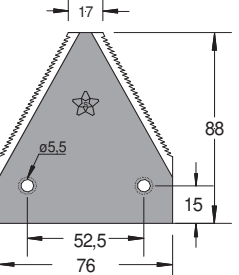

Sotto rigata
Spess. 3
Svasata

Applicazione G&S 394-402
(sv. sopra) Gribaldi & Salvia 036
(sv. sotto) Gribaldi & Salvia 14670

89x3 S f.5,5 3F

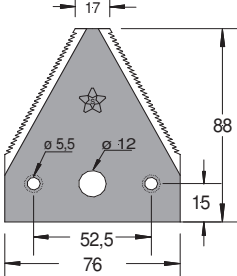

Sotto rigata
Spess. 3
Svas. sotto

Applicazione G&S 394-402
Gribaldi & Salvia 14672

89x3 SF

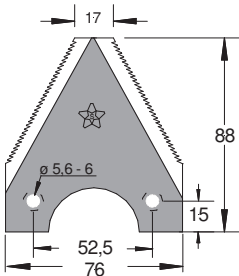

Sotto rigata
Spess. 3
Svas. sotto

I.M.A. La rocca



SEZIONI DI LAME FALCIATRICI - MOWERS BLADES
KLINGEN FÜR MAHMASCHINEN - SECTIONS FAUCHEUSES
SECCIONES CUCHILLAS MOTOSEGADORAS - СЕГМЕНТЫ ДЛЯ КОСИЛОК

Codice

Adattabili a:

Codice

Adattabili a:

DIN 75

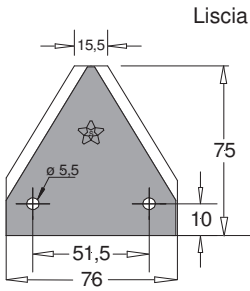

Liscia / Sotto rigata
Spess. 2

Fortschritt 4105.000.99.8 (S)
Stockey & Schmits 100.22.14
Aebi

DIN 80 S - 222 S

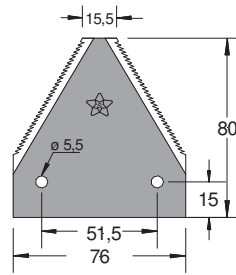

Sotto rigata
Spess. 2

D.Fahr - Kuhn - Steir
Aebi - Reform - Bucher
Rapid 22222
Rasspe RS7500 R
Gaspardo 20800064
(liscia) Rasspe RS7500
(liscia) Gaspardo 20800065

DIN 80 5 fori

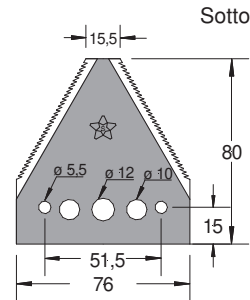

Sotto rigata / liscia
Spess. 2 / 3

Rapid D304

27096 S sv.

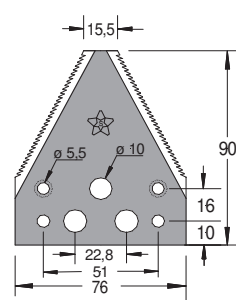

Sotto rigata
Spess. 2
Svas. sotto

Bcs 580 27096

28096 S sv.

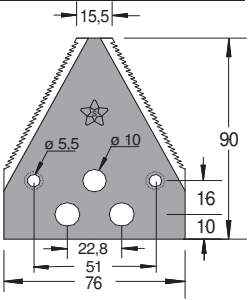

Sotto rigata
Spess. 2,5
Svas. sotto

Bcs 580 28096

59014 S sv.

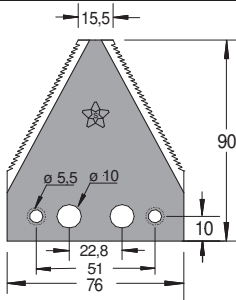

Sotto rigata
Spess. 2

Bcs 580 59014

D2001 S

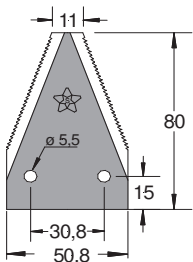

Sotto rigata
Spess. 2,5

Bcs 580 48945
Benassi
Barbieri
Bertolini
Losi

D2001 S h.74 sv.

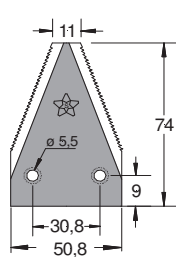

Sotto rigata
Spess. 2,5
Svas. sotto

D2002 S

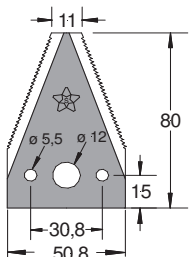

Sotto rigata
Spess. 2,5

Cavalli 3516

D2002 S h.74 sv.

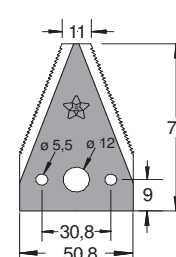

Sotto rigata
Spess. 2,5
Svas. sotto



SEZIONI DI LAME FALCIATRICI - MOWERS BLADES
KLINGEN FÜR MAHMASCHINEN - SECTIONS FAUCHEUSES
SECCIONES CUCHILLAS MOTOSEGADORAS - СЕГМЕНТЫ ДЛЯ КОСИЛОК

Codice

Adattabili a:

Codice

Adattabili a:

3550 S sv.

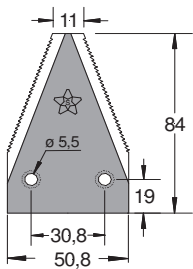

Sotto rigata
Spess. 3
Svas. sotto

Cavalli

2148 S

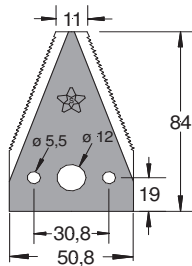

Sotto rigata
Spess. 2,5

Cavalli

50696 S sv.

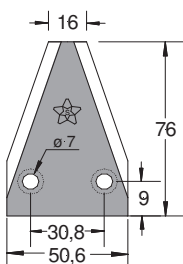

Sotto rigata
Spess. 2,5
Svas. sotto

Bcs

563 50696

50684 LL sv.

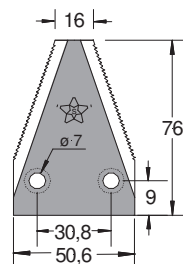

Liscia
Spess. 2,5
Svas. sotto

Bcs

563 50684

59015 S sv.

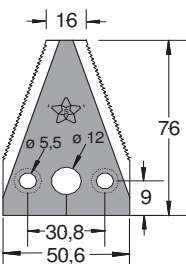

Sotto rigata
Spess. 2,5
Svas. sotto

Eurosystems 26102005/1

Bcs

563 59015

59016 LL sv.

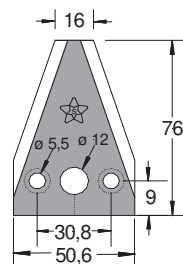

Liscia
Spess. 2,5
Svas. sotto

Bcs

563 59016

58716 S

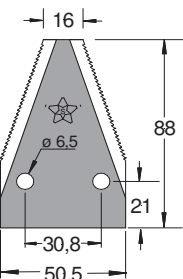

Sotto rigata
Spess. 2,5



Bcs

563 58716

BCS 563 58761 (senza alleggerimento)

85315 S

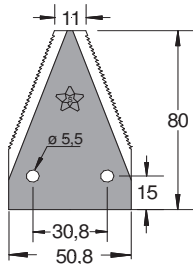

Sotto Rigata
Spess. 2

Fort

Bcs 580 48945

85316 LL

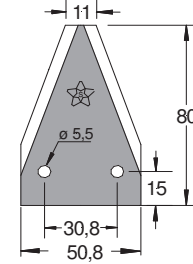

Liscia
Spess. 2

Fort

ST 7000 f.6,25 sv. sopra

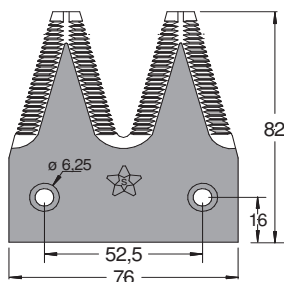

Sopra rigata
Spess. 2,7
Svasata sopra



Gaspardo

13013540

ST 7000 f.6,25 sv. sotto

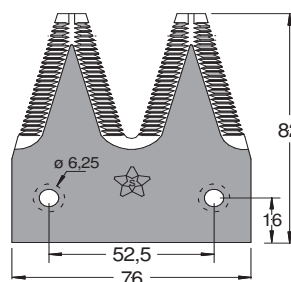

Sopra rigata
Spess. 2,7
Svasata sotto



Gaspardo

13013550



SEZIONI DI LAME FALCIATRICI - MOWERS BLADES
KLINGEN FÜR MAHMASCHINEN - SECTIONS FAUCHEUSES
SECCIONES CUCHILLAS MOTOSEGADORAS - СЕГМЕНТЫ ДЛЯ КОСИЛОК

Codice

Adattabili a:

Codice

Adattabili a:

GB 2730

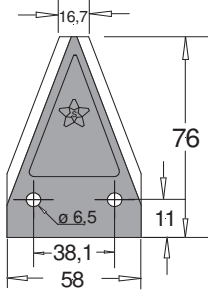

Liscia
 Spess. 2,5
 Svasata sotto

Busatis 580200901

GB 2731

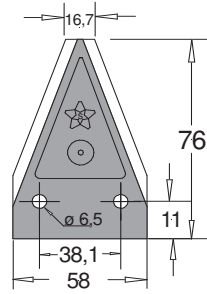

Liscia
 Spess. 2,5
 Svasata sotto
 Con piolo

Busatis 580201101
 Esm 244151

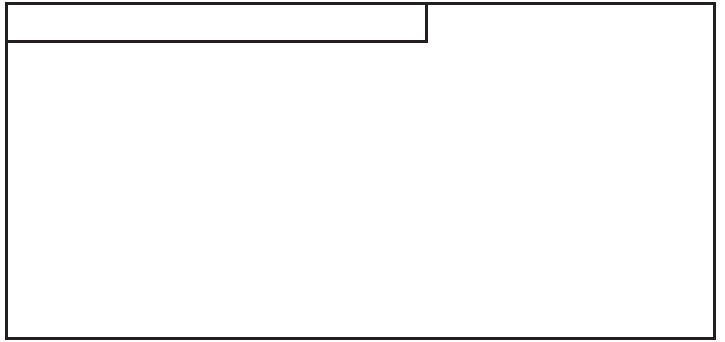
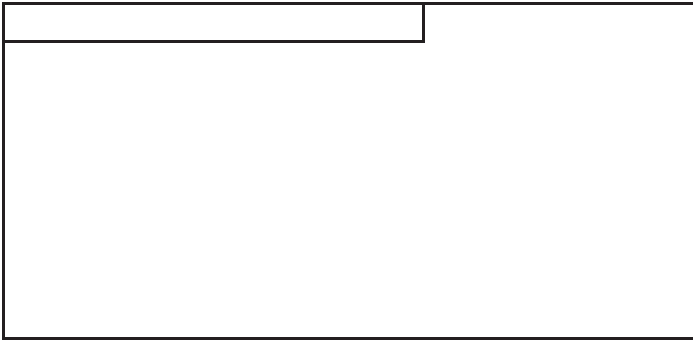
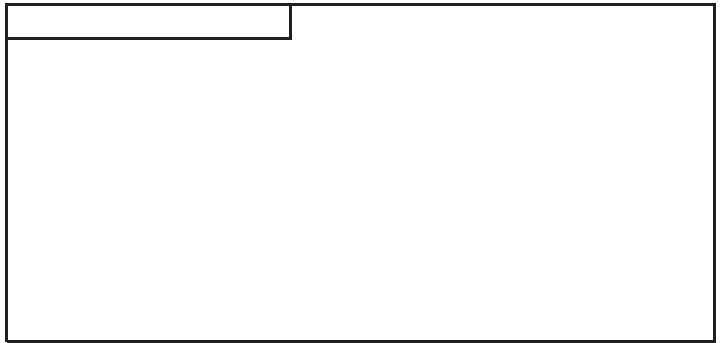
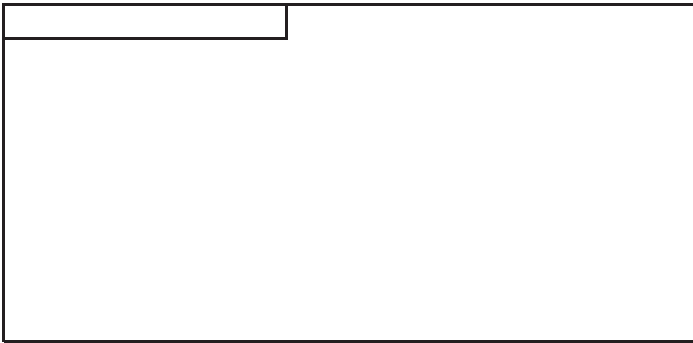
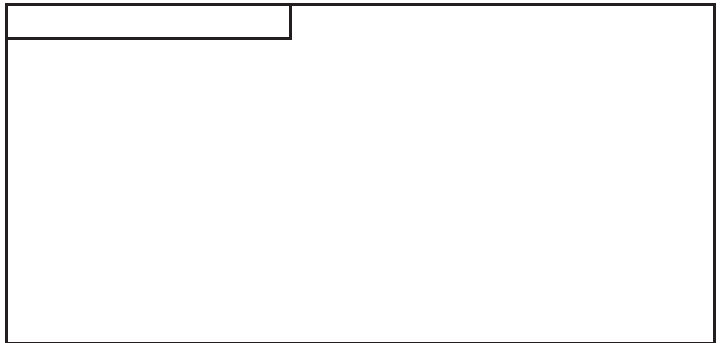
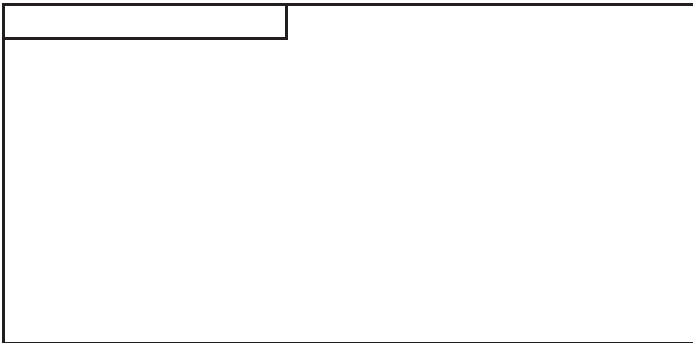
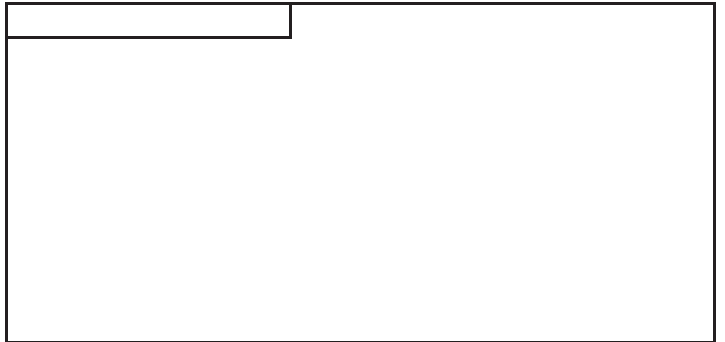
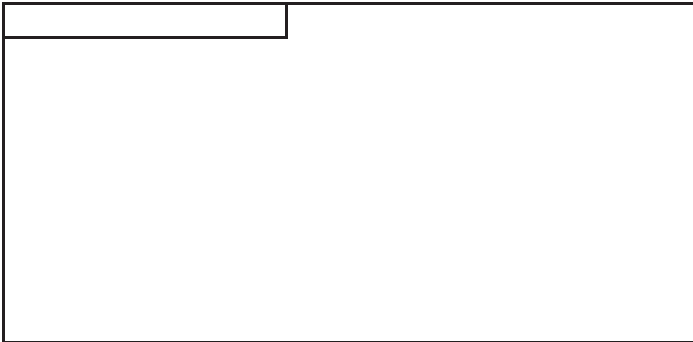

SEZIONI DI LAME FALCIATRICI - MOWERS BLADES
KLINGEN FÜR MAHMASCHINEN - SECTIONS FAUCHEUSES
SECCIONES CUCHILLAS MOTOSEGADORAS - СЕГМЕНТЫ ДЛЯ КОСИЛОК

Codice

Adattabili a:

Codice

Adattabili a:



SEZIONI DI LAME MIETITREBBIA

www.stellalame.com

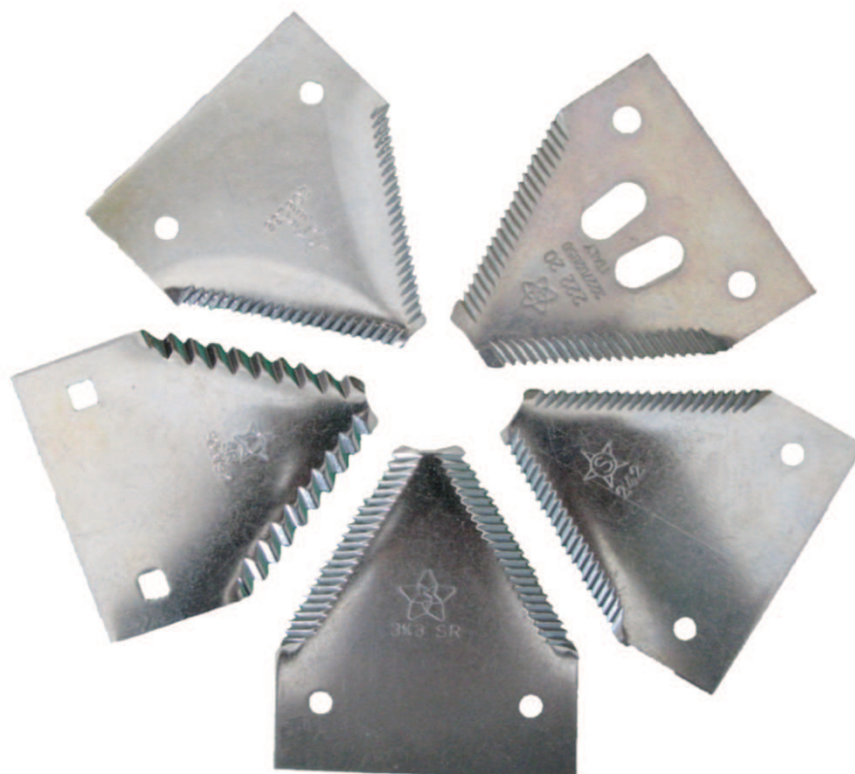

SEZIONI DI LAME MIETTITREBBIA - COMBINE HARVESTER BLADES
MAHDRESCHER - MOISSONNEUSES BATTEUSES
SECCIONES DE COSECHADORA - СЕГМЕНТЫ ДЛЯ ЗЕРНОУБОРОЧНЫХ КОМБАЙНОВ

Codice

Adattabili a:

Codice

Adattabili a:

343 S

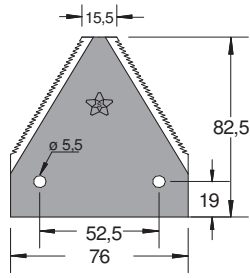

Sotto rigata
Spess. 3

Clyson
New Holland 80365111

343 SR f.6,8

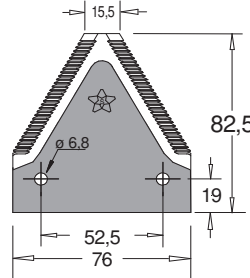

Sopra rigata
Spess. 2,7

New Holland
Laverda 321219850

343 SR f.5,5

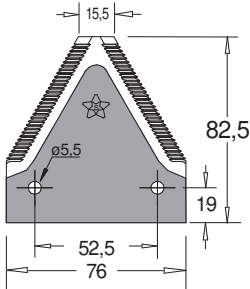

Sopra rigata
Spess. 2,7

Laverda 365110
New Holland 80365110

343 SR f.6,25

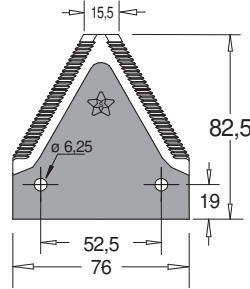

Sopra rigata
Spess. 2,7

New Holland 87728899
Cnh 84429103

242 S

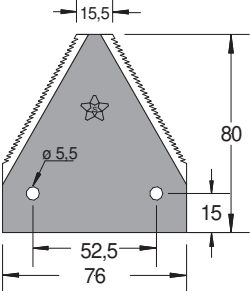

Sotto rigata
Spess. 2

Laverda 340443003
LF9R - 333 (MA-MB-ME)
Rasspe ME333-MB333

242 SR sp.2

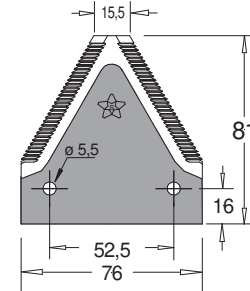

Sopra rigata
Spess. 2

Hesston 49213 (soia) 049924
Laverda 321088250
New Holland 340443004
Hesston 49213 (CR)
New Holland 604921D (CR)

P49650 H SR

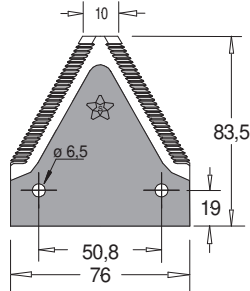

Sopra rigata
Spess. 2,7

J.Deere P49650H
J.Deere AZ32298

P49650 H S

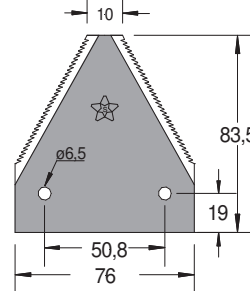

Sotto rigata
Spess. 2

J.Deere

P55650 SR

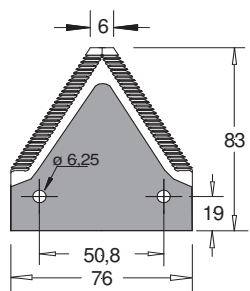

Sopra rigata
Spess. 2,7

J.Deere P55650

E 76370 SR

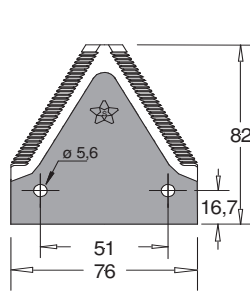

Sopra rigata
Spess. 2,7

(CR) J.Deere E 76370 - E 45996H



SEZIONI DI LAME MIETTITREBBIA - COMBINE HARVESTER BLADES
MAHDRESCHER - MOISSONNEUSES BATTEUSES
SECCIONES DE COSECHADORA - СЕГМЕНТЫ ДЛЯ ЗЕРНОУБОРОЧНЫХ КОМБАЙНОВ

Codice

Adattabili a:

Codice

Adattabili a:

222 20

Sopra rigata
Spess. 2,7

**Disponibile versione
Zincata (ZN)**

Sch 420100045 E28 - Sch 10961.06 (d.ti 20)
Sch 420100046 C23 - Sch 10966.06 (d.ti 25)
Sch 10978.06 (d.ti 14) - Agco 71386924
J.D. Z93077 (d.ti 20) - J.D. Z93078 (d.ti 25)
J.D. AZ52672 - AZ40032 - AZ47493
Deutz Fahr 16007763 - CNH 4260714246
Laverda 322702850 - Laverda 327840145

222 20F

Sopra rigata
Spess. 2,7

J.Deere
Deutz Fahr

222 U

Sopra rigata
Spess. 2,7

Sch 420 100 015
J.Deere AZ 40032

222 UF

Sopra rigata
Spess. 2,7

J.Deere AZ 40032
Sch 420 100 015
M.D.W - Fortschritt 4260-71424-6

222 T

Sopra rigata
Spess. 2,7

Sch 10961.03
J.Deere Z47493
Sch. 420.100.001
Deutz Fahr 065.035.30

DIN 80 S / L

Sotto Rigata / liscia
Spess.2
Disponibile anche spessore 3

Deutz Fahr 06227771 (S)
Deutz Fahr 06227769 (L)
Claas 522187 (S)
Claas 522188 (L)
J.Deere
New Holland 80 420.016

DIN 80 3SR - DIN LAND 300

Sopra rigata
Spess. 2,7

Claas Din Land 300

DIN 80 2SR

Sopra rigata
Spess. 2

J. Deere
Claas 522187
New Holland 80 420.019 = MZ534.062.05

E 76371 S

Sotto rigata
Spess. 3

(CR) J.Deere E 76371 - H 21530

611318 L

Liscia
Spess. 3

Claas 611318



SEZIONI DI LAME MIETTITREBBIA - COMBINE HARVESTER BLADES
MAHDRESCHER - MOISSONNEUSES BATTEUSES
SECCIONES DE COSECHADORA - СЕГМЕНТЫ ДЛЯ ЗЕРНОУБОРОЧНЫХ КОМБАЙНОВ

Codice

Adattabili a:

Codice

Adattabili a:

611203.1 SR

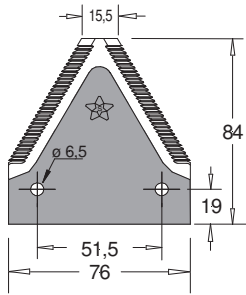

Sopra rigata
Spess. 2,7

Claas 611203.1

611316 S

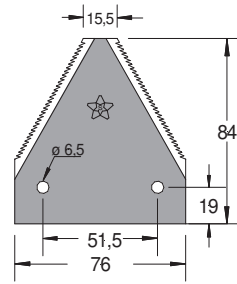

Sotto rigata
Spess. 3

Claas 611316

9145 S

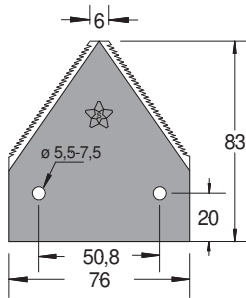

Sotto rigata
Spess. 2

Arbos 59174 (f.5,5)
Arbos 9145 (f.7,5)

9145 SR

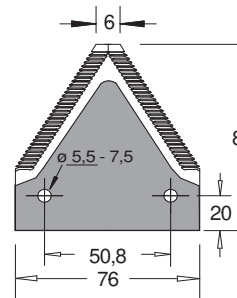

Sopra rigata
Spess. 2,7

Arbos J.Deere PK23700H

206236 S

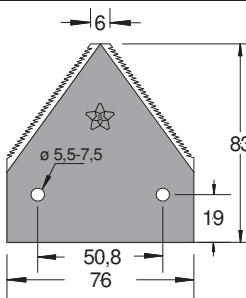

Sotto rigata
Spess. 3

Lova 20623614

206236 SR M1H

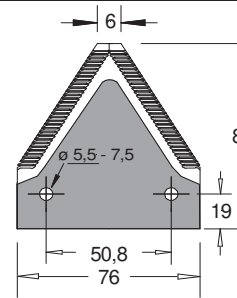

Sopra rigata

Spessore 2 mm
Arbos 64861 (f.5,5) - 64860 (f.7,5)
Massey Ferguson - Lova
33176117 M1
Spessore 2.7 mm
Arbos 70899 (f.5,5) - 70897 (f.7,5)
Sampo 498820

309197 SR

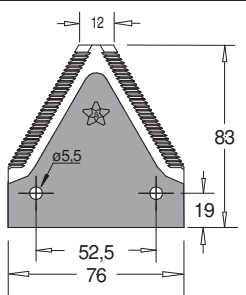

Sopra rigata
Spess. 2,7

New Holland 80309197
Clyson
J.Deere H79611 - H84413
J.Deere H125893 (Cromata)

309197 S

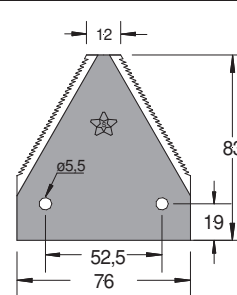

Sotto rigata
Spess. 3

New Holland 80322481
Clyson 322481
Laverda 340443023
J.Deere 84415
Claas

309197 SR Q

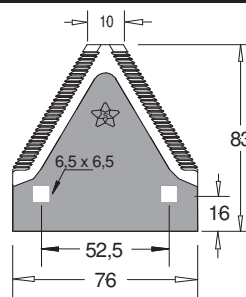

Sopra rigata
Spess. 2,7

New Holland 80755207
New Holland 84998682
New Holland 84992425
New Holland 80755207 CR

CA826720 C2

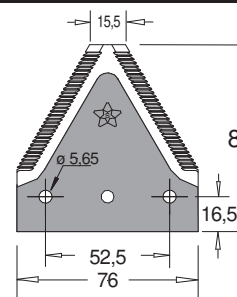

Sopra rigata
Spess. 2,7

Cnh 112074
Case CA826720 C2



SEZIONI DI LAME MIETTITREBBIA - COMBINE HARVESTER BLADES
MAHDRESCHER - MOISSONNEUSES BATTEUSES
SECCIONES DE COSECHADORA - СЕГМЕНТЫ ДЛЯ ЗЕРНОУБОРОЧНЫХ КОМБАЙНОВ

Codice

Adattabili a:

Codice

Adattabili a:

242 SR sp.3

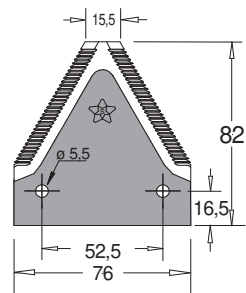

Sopra rigata
Spess. 2,7

Cnh 49254
Dronningborg 44100000
Hesston 049916 = 049254
PT / 1010
700702966 - MC 333.5
Hesston 049916 (CR)
Hesston 049254 (CR)

242 SR sp. 3 f.6,5

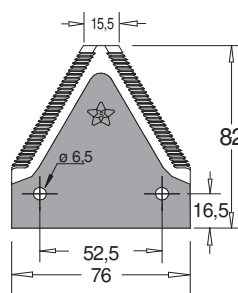

Sopra rigata
Spess. 2,7

Dronningborg 44103700

MCD SR

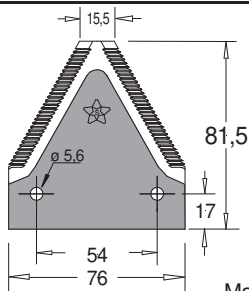

Sopra rigata
Spess. 2,7

Mac Don 102053 (dente grosso)
Mac Don 158516 (dente grosso)
Mac Don 34390 (dente fine) - App. Case 87422066

86615988 SR

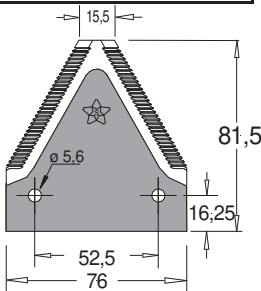

Sopra rigata
Spess. 2,7

Cnh 86615988

86615986 SR

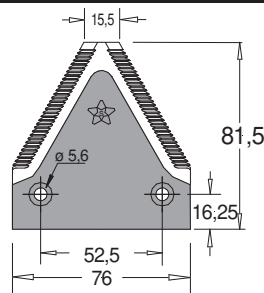

Sopra rigata
Spess. 2,7
sv. sopra

Cnh 86615986

86615987 SR

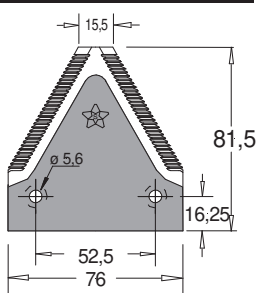

Sopra rigata
Spess. 2,7
sv. sotto

Cnh 86615987

ST 7000

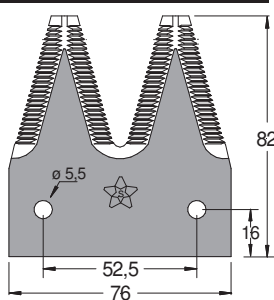

Sopra rigata
sp. 2,7
Disp. anche zincata

GB 7000
Claas 650561.0
New Holland 848093

ST 6000

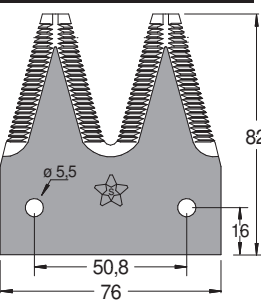

Sopra rigata
sp. 2,7
Disp. anche zincata

DC 6000
GB 6000 (sv. sopra)
Laverda 320802350 (sv. sotto)

ST 163131

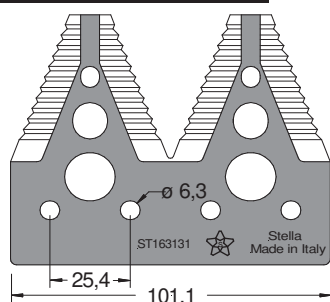

Sopra rigata
sp. 2,7
Dente grosso

John Deere H163131

ST 153329

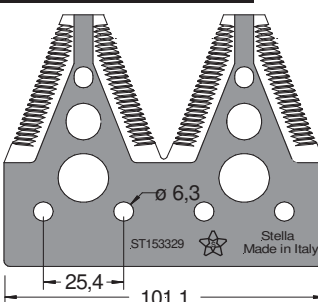

Sopra rigata
sp. 2,7
Dente fine

John Deere H153329



SEZIONI DI LAME MIETTIREBBIA - COMBINE HARVESTER BLADES
MAHDRESCHER - MOISSONNEUSES BATTEUSES
SECCIONES DE COSECHADORA - СЕГМЕНТЫ ДЛЯ ЗЕРНОУБОРОЧНЫХ КОМБАЙНОВ

Codice

Adattabili a:

Codice

Adattabili a:

--

--

--

--

--

--

--

--

--

--



LAME PER VITICOLTURA E CIMATRICI

www.stellalame.com

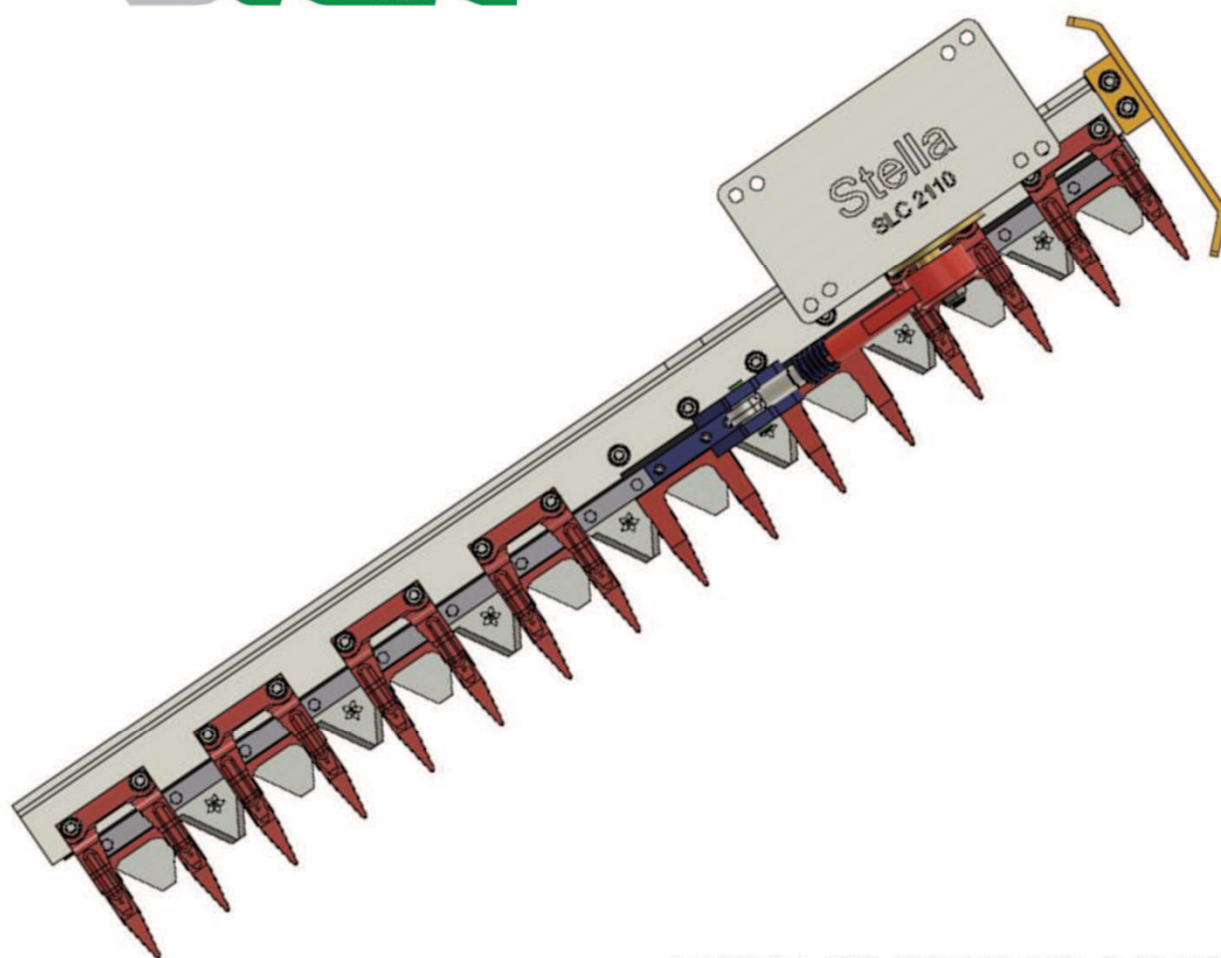

NEW CUTTING UNIT
Testa rossa
for viticulture & forest

NEW CUTTING UNIT

Testa rossa

for viticulture & forest

Testa Rossa è la nuova cutting unit di STELLA ideale per il taglio di vegetazione e secco fino a 3 cm di diametro. Disponibile in tre lunghezze standard e pronta per essere montata su ogni macchina

Modello	Codice	Lunghezza (cm)	Taglio diam (mm)	Dimens.	Numero giri (max)	Peso (Kg)	Motori Cm3*
TR 120	SLC 2110	120	25/30	122x20	350	29	50/80/100
TR 150	SLC 2120	150	25/30	152x20	350	36	50/80/100
TR 180	SLC 2130	180	25/30	182x20	350	43	50/80/100

*Motore opzionale

Impieghi: **viticoltura, forestale e manutenzione del verde**



LAME PER VITICOLTURA E CIMATRICI - BLADES FOR VITICULTURE
KLINGEN FÜR DEN WEINBAU - SECTIONS POUR LA VITICULTURE
CUCHILLAS PARA LA VITICULTURA - НОЖИ СТРИГАЛЬНЫХ МАШИН ДЛЯ ВИНОГРАДСТВА

Codice

Adattabili a:

Codice

Adattabili a:

89x3 S f. 5,5

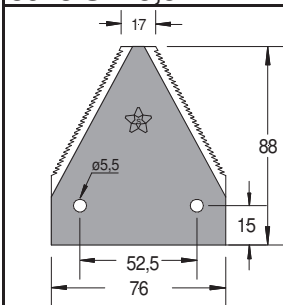

Sotto rigata
Spess. 3

222 20

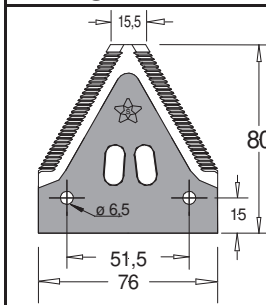

Sopra rigata
Spess. 2,7

Disponibile versione
Zincata (ZN)

DIN 80 3SR - DIN LAND 300

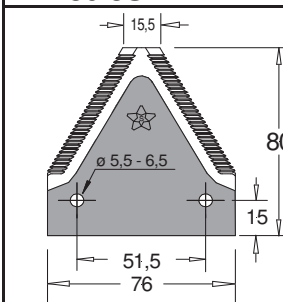

Sotto rigata
Spess. 2,7

FRANCIACORTA

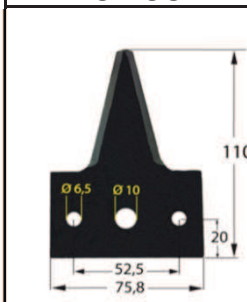

Lama
Spess. 3
Sv. sotto

Cavalli

VITE ITALIANA

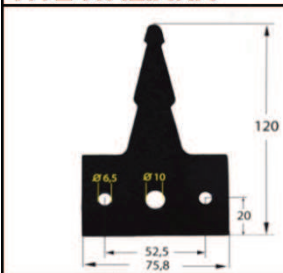

Dente
Spess. 3
Sv. sotto

Cavalli

STDM 01 UNIVERSALE



Forgiato

NEW

Sch 41010001
Sch 16500

P/lama Sup.



Premilama Superiore

P/lama Inf.



Premilama Inferiore

DM 1



Sch 41010001
Sch 16500

Codice barre
Code bars

N° lame/denti
N° sections/fingers

Lunghezza
Length

Note
Notes

Codice barre Code bars	N° lame/denti N° sections/fingers	Lunghezza Length	Note Notes
SLC 2010	24/25	1,90	Barra verticale
SLC 2020	20/21	1,60	Barra verticale
SLC 2030	26/27	2,05	Barra verticale
SLC 2040	11/12	0,85	Barra orizzontale

Disponibili anche le aste montate con lame Franciacorta o denti Vite Italiana non assemblate in barre



LAME PER VITICOLTURA E CIMATRICI - BLADES FOR VITICULTURE
KLINGEN FÜR DEN WEINBAU - SECTIONS POUR LA VITICULTURE
CUCHILLAS PARA LA VITICULTURA - НОЖИ СТРИГАЛЬНЫХ МАШИН ДЛЯ ВИНОГРАДСТВА

Codice

Adattabili a:

Codice

Adattabili a:



LAME PER BIOTRITURATORI

www.stellalame.com



BIOTRITURATORI - BIO SHREDDER
БИОНАЕКСЛЕР - БРОЙЕРС
BIOTRITURADORES - НОЖИ ДЛЯ БИОИЗМЕЛЬЧИТЕЛЕЙ

Codice

Adattabili a:

Codice

Adattabili a:

W DIN 80

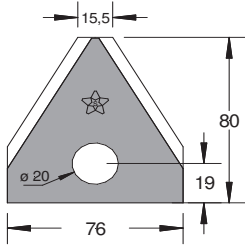

Liscia
Spess. 2

Wagner

222 1 F

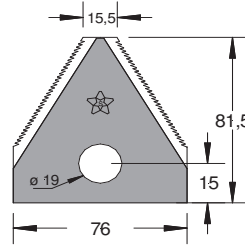

Sotto rigata
Spess. 2 / 3

Nagri

BIO T1

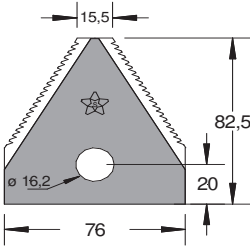

Sotto rigata
Spess. 3

Bio Caravaggi 60-80

BIO T2

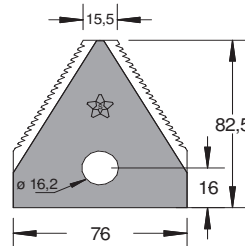

Sotto rigata
Spess. 3

Bio Prof Caravaggi 50-150

SG 26

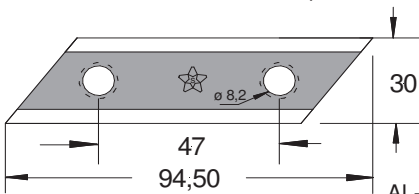

Liscia
Spess. 3

AL-KO 325967
Sandrigarden 261800

SG 27

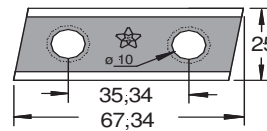

Liscia
Spess. 2

Sandrigarden 275420

D2001 L TA

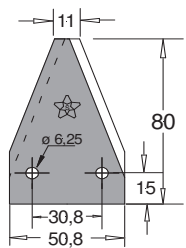

Liscia
Spess. 2,5



COLTELLI PER FALCIATRICI ROTATIVE

www.stellalame.com



COLTELLI PER FALCIATRICI ROTATIVE - ROTARY MOWER KNIVES
ROTOR KLINGEN - COTEAUX DE FAUCHEUSES ROTATIVES
CUCHILLAS PARA SEGADORAS ROTATIVAS - НОЖИ ДЛЯ РОТОРНОЙ КОСИЛКИ

DIRITTO - STRAIGHT
GERADE - DROIT - DERECHO - Прямой

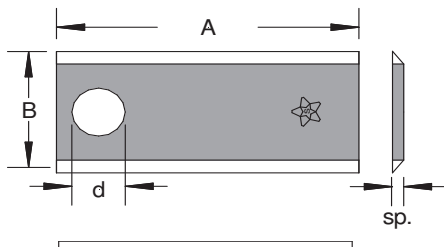

CODICE STELLA					APPLICAZIONE	ADATTABILI A ORG
D	A	B	d	sp.		
D	83	40	19	3	FAHR KRONE KRONE	1.1019.010.282.00 1431490 1372 242 7
D	88	40	19	3	CLAAS FAHR FAHR FELLA GARNIER KRONE KRONE LINCE NIEMEYER PÖTTINGER RS WELGER ZWEEGERS	977.516.0 0653 1543 1-1019-010-271.20/88 477 741 4460101001 141071.0 143149.3 088 D 11.065 434992 15 01 331 0982.1501.00 MT 52
D	90	40	19	3	CLAAS FAHR FAHR (NEW) FELLA IHC IHC KRONE NIEMEYER NIEMEYER PÖTTINGER RASSPE RASSPE WELGER ZWEEGERS	977 516.0 1-1019-010-271.20/90 0656 1543 477 741 1133937 R1 3101549 R1 143 149 4 570 400 11.065 434992 1.501.331 80-10-46 0982.15.01.00 MT 52S
D	94	40	19	3	CLAAS FAHR FAHR (NEW) FARENDLOSE NIEMEYER RASSPE	978 186.0 1-1012-030-115.00 0656 1542 00.0114.054 11.079 RS 20.01.331
D	94	40	16,25	3	KUHN NEW HOLLAND NEW HOLLAND	561.500.00 549 757 274 230



COLTELLI PER FALCIATRICI ROTATIVE - ROTARY MOWER KNIVES
ROTOR KLINGEN - COTEAUX DE FAUCHEUSES ROTATIVES
CUCHILLAS PARA SEGADORAS ROTATIVAS - НОЖИ ДЛЯ РОТОРНОЙ КОСИЛКИ

DIRITTO - STRAIGHT
GERADE - DROIT - DERECHO - Прямой

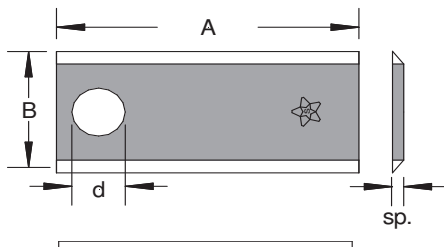

CODICE STELLA					APPLICAZIONE	ADATTABILI A ORG
	A	B	d	sp.		
D	96	40	19	3	CASE CLAAS FARENDLOSE FAHR (NEW) FAHR FELLA FELLA IHC IHC (JI CASE) KRONE NIEMEYER PÖTTINGER PÖTTINGER PZ MT WELGER	113 3941 R1 978 241.4 00-011-054 0656 1542 1.1012.030.115.00 477 740 116 954 3101547 R1 1133936 R1 143698.0 570 404 434 991 700 06 165 0 452 S 09821506.00
D	98	40	19	3	BCS FAHR FARENDLOSE FORT GALFRE' MARANGON MORRA	580.29045.4 671 36/49 00.011.069 98D 98D 98D 98D
D	100	40	19	3	BCS FAHR	580 29045
D	108	40	19	3	MORRA	108/D
D	96	48	21	3	SIP	152 147 607
D	100	48	19	3		
D	100	48	21	3		
D	105	48	21	3	HAGEDORN SIP ZWEEGERS	1 4 7040 151019702 CM15
D	108	48	21	3	BELLON BELLON GALFRE' MORRA MARANGON NEW HOLLAND PZ	1803364 108D 108D 108D 108D 495 806 CM15 = 108D
D	108	48	19	3	GALFRE'	108D/19
D	96	40	19	4	CLAAS CLAAS JF FREUDENDAHL FELLA FELLA	949 240.0 949 240 .1 130-0025 477 762 116 956
D	108	40	19	4	GALFRE'	108D/19
D	102	45	16,5	4		
D	123	45	18,2	4	KUHN	564.512.10
D	105	48	19	4	FELLA	122.331
D	108	48	19	4	FORTSCHRITT	0310 4179 504



COLTELLI PER FALCIATRICI ROTATIVE - ROTARY MOWER KNIVES
ROTOR KLINGEN - COTEAUX DE FAUCHEUSES ROTATIVES
CUCHILLAS PARA SEGADORAS ROTATIVAS - НОЖИ ДЛЯ РОТОРНОЙ КОСИЛКИ

PIEGATO NORMALE - NORMAL BENDED
NORMAL GEBOGEN - PLIE' NORMALE - DOBLADA
Изогнутый

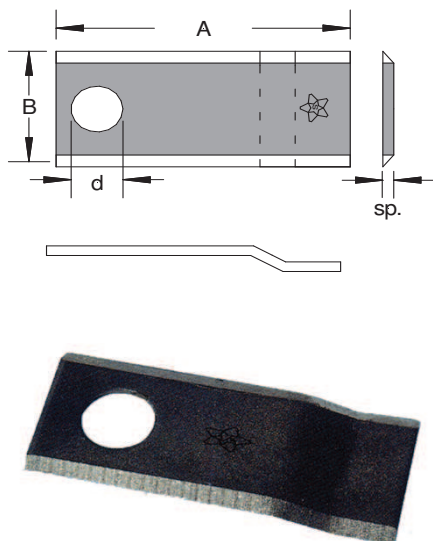

CODICE STELLA					APPLICAZIONE	ADATTABILI A ORG
	A	B	d	sp.		
PN	88	40	19	3	LINCE SUPERTINO	90P 88 P
PN	90	40	19	3	LINCE	90/P
PN	94	40	19	3	BELLON FAHR MORRA MARANGON	1-1017-010-153.22 94 P
PN	96	40	19	3	FAHR FAHR (NEW) FELLA FELLA IHC PÖTTINGER ZWEEGERS	1-1017-010-153.00 0656 1541 478 962 = 478.963 124 243 1133938R1 434993 TT97
PN	98	40	19	3	FAHRENDLOSE FELLA FORT FAHR GALFRE' MARANGON MORRA	00-11-07 124243 98P 98P 98P 98P
PN	108	40	19	3		
PN	105	48	21	3		
PN	108	48	19	3	GALFRE' BELLON GALFRE' NEW HOLLAND	108P 1803365 108P 495 807
			21			

PIEGATO FORTE - STRONG BENDED
STARK GEBOGEN - FORT PLIE' - DOBLADA FUERTE
Сильно изогнутый

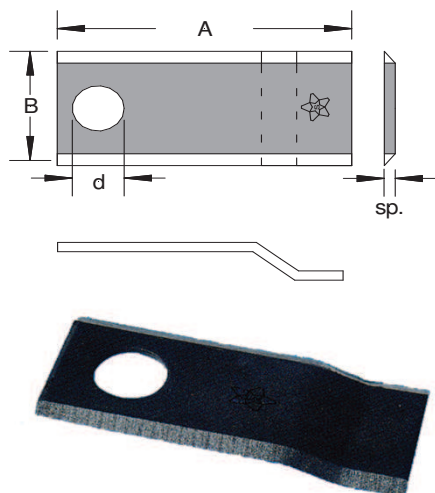

CODICE STELLA					APPLICAZIONE	ADATTABILI A ORG
	A	B	d	sp.		
PF	96	40	19	3	SUPERTINO P.F.	
PF	98	40	19	3		
PF	108	50	17	4	MAXAM	



COLTELLI PER FALCIATRICI ROTATIVE - ROTARY MOWER KNIVES
ROTOR KLINGEN - COTEAUX DE FAUCHEUSES ROTATIVES
CUCHILLAS PARA SEGADORAS ROTATIVAS - НОЖИ ДЛЯ РОТОРНОЙ КОСИЛКИ

ELICOIDALE - HELICOIDAL
SCHRAUBENFORMIG - HELICOIDAL - Винтовой

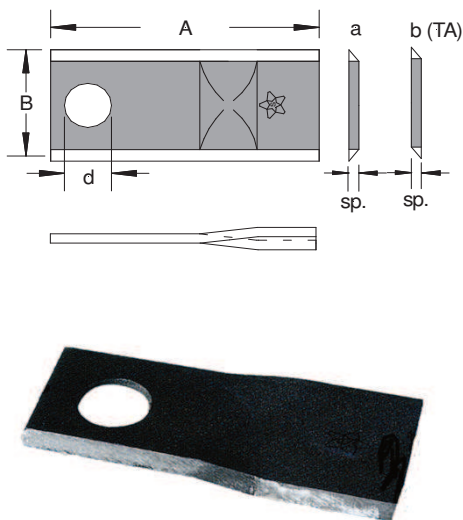

CODICE STELLA					APPLICAZIONE	ADATTABILI A ORG	LATO	
EL	A	B	d	sp.				
EL 88	88	40	16,25	3	a	KUHN	561.510.00	SX
						KUHN	561.511.00	DX
EL 90	90	40	19	3	b	WELGER	0982.15.08.00	SX
						WELGER	0982.15.09.00	DX
EL 93	93	40	16,25	3	a	CASE	113 3939	SX
						CASE	113 3940	DX
						GASPARDO	513	SX
						GASPARDO	512	DX
						IHC (JI CASE)	1133939R1	SX
						IHC (JI CASE)	1133940R1	DX
						IHC (JI CASE)	3160419R1	SX
						IHC (JI CASE)	3160420R1	DX
						JOHN DEERE	CC 19 336	SX
						JOHN DEERE	CC 19 333	DX
						KUHN	561.512.00	SX
						KUHN	561.513.00	DX
						NEW HOLLAND	274 096	SX
						NEW HOLLAND	274 097	DX
EL 94	94	40	19	3	b	KRONE	147 419 5	SX
						KRONE	147 302 5	DX
						NEW HOLLAND	402 244	SX
						NEW HOLLAND	402 243	DX
EL 96	96	40	19	3	a	FAHR	1.1603.010.197.00	SX
						FAHR	1.1603.010.198.00	DX
						FAHR	0656 1547	SX
						FAHR	0656 1546	DX
						FAHR	1650 2727	SX
						FAHR	1650 2726	DX
						PÖTTINGER	434 996	SX
						PÖTTINGER	434 995	DX
EL 100	100	40	19	3	b	BCS	58029096	SX
						BCS	58029095	DX
						GRIBALDI & SALVIA	26013/S	SX
						GRIBALDI & SALVIA	26013/D	DX
EL 93	93	48	19	3	b	KRONE	151 386 0	SX
						KRONE	151 385 0	DX
						KRONE	145 869 1	SX
						KRONE	145 868 1	DX



COLTELLI PER FALCIATRICI ROTATIVE - ROTARY MOWER KNIVES
ROTOR KLINGEN - COTEAUX DE FAUCHEUSES ROTATIVES
CUCHILLAS PARA SEGADORAS ROTATIVAS - НОЖИ ДЛЯ РОТОРНОЙ КОСИЛКИ

ELICOIDALE - HELICOIDAL
SCHRAUBENFORMIG - HELICOIDAL - Винтовой

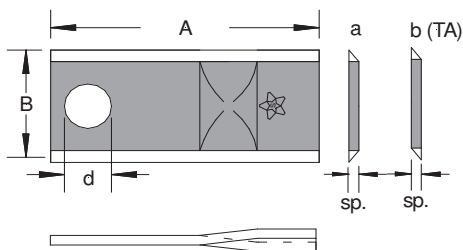

CODICE STELLA					APPLICAZIONE	ADATTABILI A ORG	LATO	
	A	B	d	sp.				
EL	94	48	19	3	b	CLAAS	104.339.0	SX
						CLAAS	104.340.0	DX
						KRONE	151386.0	SX
						KRONE	151385.0	DX
						NIEMEYER	570 409	SX
						NIEMEYER	570 410	DX
					a	FELLA	121 692	SX
						FELLA	121 693	DX
						ZWEEGERS	TF 70	SX
						ZWEEGERS	TF 71	DX
EL	100	48	19	3	b	CLAAS	952 729.0	SX
						CLAAS	952 728.0	DX
						CLAAS	904.178.6	SX
						CLAAS	904.177.6	DX
						CLAAS	904.178.7	SX
						CLAAS	904.177.7	DX
						CLAAS	904.797.0	SX
						CLAAS	904.796.0	DX
						FORTSCRITT	0301 1680	SX
						FORTSCRITT	0301 1697	DX
						NIEMEYER	570 413	SX
						NIEMEYER	570 414	DX
						NIEMEYER	570 419	SX
						NIEMEYER	570 418	DX
PÖTTINGER	434983	SX						
PÖTTINGER	434984	DX						
EL	105	48	19	3	b	CLAAS	904 178.8	SX
						CLAAS	904 177.8	DX
						ZWEEGERS	DN 382	SX
						ZWEEGERS	DN 383	DX
						CLAAS	104 266.0	SX
			CLAAS			104 267.0	DX	
			21			KVERNELAND	CM 137	SX
						KVERNELAND	CM 138	DX
						ZWEEGERS	CM 137	SX
						ZWEEGERS	CM 138	DX
GALFRE'	108 EL	SX						
GALFRE'	108 EL	DX						
EL	110	48	21	3	a	CLAAS	105 878.0	SX
						CLAAS	105 873.0	DX
EL	110	48	21	3	b	COMER	0404 7016	SX
						COMER	0404 7015	DX
EL	108	40	19/21	4	b	GALFRE'		SX
						GALFRE'		DX
EL	94	48	19	4	b	BCS	58.031.193	SX
						BCS	58.031.192	DX
						KVERNELAND	TA 321	SX
						KVERNELAND	TA 322	DX
						PZ / ZWEEGERS	TA-321	SX
						PZ / ZWEEGERS	TA-322	DX



COLTELLI PER FALCIATRICI ROTATIVE - ROTARY MOWER KNIVES
ROTOR KLINGEN - COTEAUX DE FAUCHEUSES ROTATIVES
CUCHILLAS PARA SEGADORAS ROTATIVAS - НОЖИ ДЛЯ РОТОРНОЙ КОСИЛКИ

ELICOIDALE - HELICOIDAL
SCHRAUBENFORMIG - HELICOIDAL - Винтовой

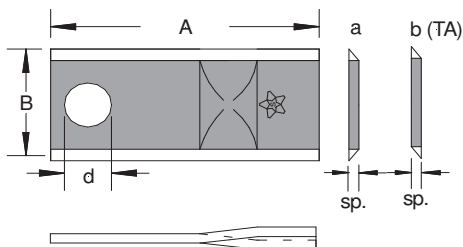

CODICE STELLA						APPLICAZIONE	ADATTABILI A ORG	LATO
	A	B	d	sp.				
EL	96	48	19	4	b	FAHR	1650 3465	SX
						FAHR	1650 3464	DX
						FAHR	1650 3460	SX
						FAHR	1650 3658	DX
						KRONE	146 690 1	SX
						KRONE	146 691 1	DX
EL	98	48	19	4	b	BCS	58.036.091	SX
						BCS	58.036.090	DX
						FELLA	121 712	SX
						FELLA	121 713	DX
						GRIBALDI & SALVIA	121713/SP	SX
						GRIBALDI & SALVIA	121712/SP	DX
						PÖTTINGER	434 981	SX
						PÖTTINGER	434 982	DX
						SIP	153 171 311	SX
						SIP	153 171 419	DX
EL	100	48	19	4	b	GRIBALDI & SALVIA	46292	SX
						GRIBALDI & SALVIA	46291	DX
						FORTSCHRITT	0300 3350	SX
						FORTSCHRITT	0300 3367	DX
						PÖTTINGER	434 973	SX
			21			PÖTTINGER	434 974	DX
						PÖTTINGER	434 977	SX
						PÖTTINGER	434 978	DX
						MARANGON	980 204.171	SX
						MARANGON	980 204.170	DX
						MARANGON	MEL 100	SX
						MARANGON	MER 100	DX
EL	102	48	19	4	b	FELLA	140 693	SX
						FELLA	140 692	DX
EL	105	48	21	4	b	MARANGON	105	SX
						MARANGON	105	DX
					a	SITREX	110.119	SX
						SITREX	110.118	DX
EL	106	48	19	4	b	SIP	153 967 201	SX
						SIP	153 967 103	DX
						SIP	950 008 609	SX
						SIP	950 008 707	DX
						SIP	950 009 001	SX
						SIP	950 009 109	DX
						NIEMEYER	570 445	SX
						NIEMEYER	570 444	DX
						FELLA	122 329	SX
						FELLA	122 330	DX



COLTELLI PER FALCIATRICI ROTATIVE - ROTARY MOWER KNIVES
ROTOR KLINGEN - COTEAUX DE FAUCHEUSES ROTATIVES
CUCHILLAS PARA SEGADORAS ROTATIVAS - НОЖИ ДЛЯ РОТОРНОЙ КОСИЛКИ

ELICOIDALE - HELICOIDAL
SCHRAUBENFORMIG - HELICOIDAL - Винтовой

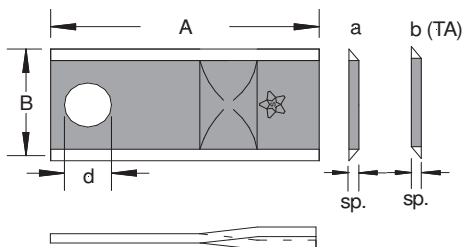

CODICE STELLA						APPLICAZIONE	ADATTABILI A ORG	LATO
	A	B	d	sp.				
EL	107	48	18,5	4	b	KVERNELAND	B 087 5002	SX
						KVERNELAND	B 087 5001	DX
						HESSTON	700.711.858	SX
						HESSTON	700.711.857	DX
						HESSTON	700.715.576	SX
						HESSTON	700.715.575	DX
EL	108	48	19	4	b	GALFRE'	434 985	SX
						GALFRE'	434 986	DX
						PÖTTINGER	434 985	SX
						PÖTTINGER	434 986	DX
						FORTSCRITT	0301 5161	SX
						FORTSCRITT	0301 5145	DX
		19h10	NIEMEYER	570 679 - 570 683	SX			
			NIEMEYER	570 680 - 570 684	DX			
			GRIBALDI & SALVIA	46362	SX			
			GRIBALDI & SALVIA	46363	DX			
			PÖTTINGER	434 971	SX			
			PÖTTINGER	434 972	DX			
21	GALFRE'		SX					
	GALFRE'		DX					
a	SITREX	100.366	SX					
	SITREX	100.367	DX					
EL	110	48	21	4	b	MARANGON	110 MEL	SX
						MARANGON	110 MER	DX
EL	112	48	19	4	b	KRONE	139 888 0	SX
						KRONE	139 889 0	DX
						FELLA	123 706	SX
						FELLA	123 707	DX
						FELLA	131 117	SX
						FELLA	131 118	DX
						FELLA	134 309	SX
						FELLA	134 308	DX
						STOLL	1122350	SX
						STOLL	1122360	DX
J.F.	1380-0015	SX						
	1380-0014	DX						
EL	112	48	21	4	b	PÖTTINGER	434 969	SX
						PÖTTINGER	434 970	DX
EL	115	48	19	4	b	CLAAS	952.043.0	SX
						CLAAS	952.042.0	DX
EL	120	48	18,5	4	b	FELLA	111 724	SX
						FELLA	111 725	DX
						FELLA	478 640	SX
						FELLA	478 641	DX
						JOHN DEERE	CC 21780	SX
						JOHN DEERE	CC 21781	DX



COLTELLI PER FALCIATRICI ROTATIVE - ROTARY MOWER KNIVES
ROTOR KLINGEN - COTEAUX DE FAUCHEUSES ROTATIVES
CUCHILLAS PARA SEGADORAS ROTATIVAS - НОЖИ ДЛЯ РОТОРНОЙ КОСИЛКИ

ELICOIDALE - HELICOIDAL
SCHRAUBENFORMIG - HELICOIDAL - Винтовой

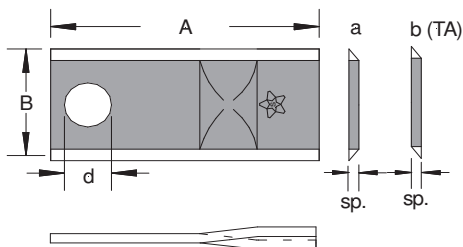

CODICE STELLA						APPLICAZIONE	ADATTABILI A ORG	LATO
	A	B	d	sp.				
EL	120	48	18,5	4	b	KVERNELAND	B 191 9802	SX
						KVERNELAND	B 191 9902	DX
						LELY	4.1201.1473.0	SX
						LELY	4.1201.1474.0	DX
						LELY	9.1127.0003.2	SX
						LELY	9.1127.0004.3	DX
						NEW IDEA	526 216	SX
						NEW IDEA	526 215	DX
						NEW HOLLAND	444 266	SX
						NEW HOLLAND	444 267	DX
						NEW HOLLAND	784 220	SX
						NEW HOLLAND	784 221	DX
PÖTTINGER	434 988	SX						
PÖTTINGER	434 989	DX						
VICON	58 699 = 90258699	SX						
VICON	58 700 = 90258700	DX						
EL	95	45	16,25	3,5	a	JOHN DEERE	CC 20 500 = 19336	SX
						JOHN DEERE	CC 20 501 = 19333	DX
						KUHN	561.512.10	SX
						KUHN	561.513.10	DX
NEW HOLLAND	766 726	SX						
NEW HOLLAND	766 727	DX						
EL	98	45	16,25	3,5	a	FORT	4049 0006	SX
						FORT	4049 0005	DX
						MORRA		SX
MORRA		DX						
EL	107	45	21	4	a	BELLON	183 2532	SX
						BELLON	183 2533	DX
						BELLON	559 032 010 /21	SX
						BELLON	559 033 010 /21	DX
ENOROSSI	12881270	SX						
ENOROSSI	12881271	DX						
EL	107	45	18,25	4	a	FORT	40490006	SX
						FORT	49490005	DX
						JOHN DEERE	CC 26 780	SX
						JOHN DEERE	CC 26 781	DX
						KUHN	559.032.10	SX
						KUHN	559.033.10	DX
NEW HOLLAND	853 819	SX						
NEW HOLLAND	853 820	DX						
EL	112	45	21	4	b	ENOROSSI	12881434 / 18034173	SX
						ENOROSSI	12881435 / 18034193	DX
EL	116	45	18,25	4	a	JOHN DEERE	CC 23 488	SX
						JOHN DEERE	CC 23 499	DX
						KUHN	559.060.00	SX
						KUHN	559.061.00	DX
NEW HOLLAND	785 608	SX						
NEW HOLLAND	785 609	DX						



COLTELLI PER FALCIATRICI ROTATIVE - ROTARY MOWER KNIVES
ROTOR KLINGEN - COTEAUX DE FAUCHEUSES ROTATIVES
CUCHILLAS PARA SEGADORAS ROTATIVAS - НОЖИ ДЛЯ РОТОРНОЙ КОСИЛКИ

ELICOIDALE - HELICOIDAL
SCHRAUBENFORMIG - HELICOIDAL - Винтовой

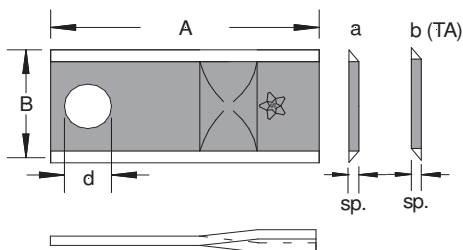

CODICE STELLA						APPLICAZIONE	ADATTABILI A ORG	LATO
	A	B	d	sp.				
EL	123	45	18,25	4	a	CLAAS	104 555.0	SX
						CLAAS	104 556.0	DX
						JOHN DEERE	CC 21 780	SX
						JOHN DEERE	CC 21 781	DX
						KUHN	564.512.00	SX
						KUHN	564.513.00	DX
EL	126	48	20,25x23	4	b	KVERNELAND	56110900	SX
						KVERNELAND	56110400	DX
						KVERNELAND	56781000	SX
						KVERNELAND	59782000	DX
						KUHN	56110900	SX
						KUHN	56110400	DX
EL	129	48	21	4	b	MARANGON	980 204.183	SX
						MARANGON	980 204.184	DX
						MARANGON	MEL 129	SX
						MARANGON	MER 129	DX
EL	105	49	21	4	TA	SAMASZ	025.05.57.00	SX
						SAMASZ	025.05.58.00	DX
EL	110	50	22,75	4	b	NEW HOLLAND	9847683	SX
						NEW HOLLAND	9847684	DX
EL	120	50	22,75	4	b	NEW IDEA / BUSH HOG	527749	SX
						NEW IDEA / BUSH HOG	527748	DX
EL	176	50	20,5	4	b	BCS	56419369	SX
						BCS	56419783	DX
EL	94	49	23	3	b	MÖRTL	T/673L	SX
						MÖRTL	T/673R	DX



COLTELLI PER FALCIATRICI ROTATIVE - ROTARY MOWER KNIVES
ROTOR KLINGEN - COTEAUX DE FAUCHEUSES ROTATIVES
CUCHILLAS PARA SEGADORAS ROTATIVAS - НОЖИ ДЛЯ РОТОРНОЙ КОСИЛКИ

PIEGATO PZ - BENDED PZ

GEBOGEN PZ - PLIE' PZ - DOBLADA PZ - Изогнутый PZ

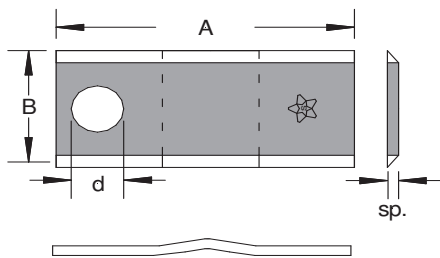

CODICE STELLA					APPLICAZIONE	ADATTABILI A ORG
	A	B	d	sp.		
PZ	105	48	21	3	BELLON PZ CM PÖTTINGER CLAAS KRONE RZS RZS ZWEEGERS GREENLAND	105 PZ 120.105 434 120 104 004.1 143 237 0 165 419500310 CM 120 CM 120
PZ	108	48	21	3	BELLON MARANGON NEW HOLLAND ZWEEGERS PZ	108 PZ CM120-108 495.807 CM 120/108
PZ	108	48	21	4	MARANGON	



COLTELLI PER FALCIATRICI ROTATIVE - ROTARY MOWER KNIVES
ROTOR KLINGEN - COTEAUX DE FAUCHEUSES ROTATIVES
CUCHILLAS PARA SEGADORAS ROTATIVAS - НОЖИ ДЛЯ РОТОРНОЙ КОСИЛКИ



VITI, DADI e BULLONI

www.stellalame.com



VITI, DADI & BULLONI - BLADE BOLT & NUT
KLINGEBOLZEN & SICHERUNGSMUTTER - BOULONS & ÉCROU
TORNILLOS & TUERCA - ВИНТЫ, ГАЙКИ И БОЛТЫ

Codice

Adattabili a: Codice

Adattabili a:

Viti per sezioni e denti mietitrebbia

M6 x 16



Laverda 322707450+360653406
 SCH 420100012+001106001
 SCH 10931 + 13961
 John Deere

M10 x 35

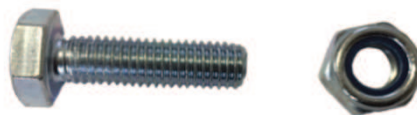

NEW

SCH 13014 + 13955
 011106621 + 011701711
 Varie

Bulloni per falciatrici rotanti

BM1215

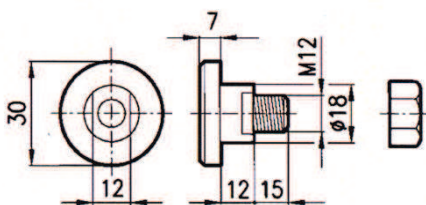

Kuhn 56115800
 J.Deere CC19994
 New Holland 687552

BM1013

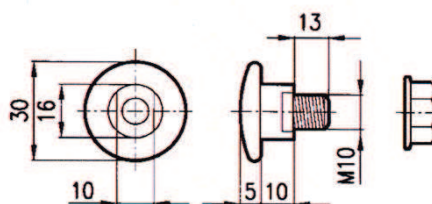

Kuhn 56210100
 J.Deere CC19989
 New Holland 274092-766728

BM1016

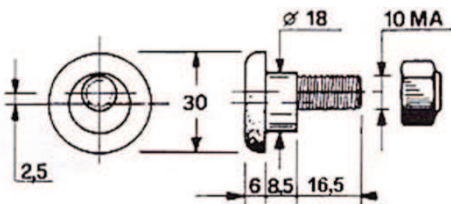

Vicon 81160
 New Holland
 John Deere

BM1218

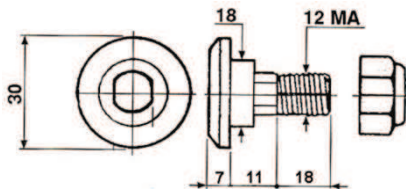

Vicon B1374593

Bulloni per coltelli carri miscelatori

M12 x 40 con nasello



NEW

Storti 161213334 (Vite)
 Storti 90800513 (Bullone)
 Storti 90809007 (Bullone autobloc.)

M10 x 35 Q



Storti
 Varie

M 12 x 40 Q

M 16 x 55 Q



Varie



TRINCIAPAGLIA & BOCCOLE

www.stellalame.com



TRINCIAPAGLIA - STRAW CHOPPER KNIVES
STROHNACKSLERMESSER - COUTEAUX BROYEUR DE PAILLE
CUCHILLAS CORTARAJAS - НОЖИ СОЛОМОИЗМЕЛЬЧИТЕЛЯ

Codice	Adattabili a:	TRATT. TERMICO	HEAT TREATMENT	
TPML 50-3-18				
	Biso	28259044	Totale	Total
	Biso	28.801.405-0014	Totale	Total
	Biso	28.801.405-0032/33	Totale	Total
	Claas	060.017.2	Foro + tagliente	Hole + cutting
	J. Deere	Z.35.221	Tagliente	Cutting
	M. Ferguson	1730 728 M2	Totale	Total
	New Holland	746 812	Totale	Total
	New Holland	80 746812	Foro + tagliente	Hole + cutting
	Laverda	321723250	Foro + tagliente	Hole + cutting
	Laverda	320706150	Totale	Total
	Deutz Fahr	0654-5847	Foro + tagliente	Hole + cutting
	Lova	28-14	Totale	Total

TPML 50-4-18				
	Dronningborg	490 18900		
	Biso	28272068	Foro + tagliente	Hole + cutting
	Biso	28.345-115		
	Biso	28.801.405-0034		
	Biso	28.272.028 / 28.274.048		
	Claas	821075.0 = 060.017.2-4		
	J. Deere	Z.48.237 / Z.53.454	Foro + tagliente	Hole + cutting
	New Holland	80 746813	Foro + tagliente	Hole + cutting
	New Holland	80 743557	Foro + tagliente	Hole + cutting
	Lova	28.14-4	Totale	Total
	Dronningborg	490 17800		
Deutz Fahr	0654 6847			

TPMS 50-3-18				
	Biso	28.274-024	Foro + tagliente	Hole + cutting
	Claas	065.294.0		

TPMS 50-4-18				
	Biso	28.274.025 / 28.274.036	Foro + tagliente	Hole + cutting
	Biso	28-345-117		
	Biso	28.274-051		
	Biso	28-14-4 Z		
	New Holland	9510635	Foro + tagliente	Hole + cutting
	New Holland	89815911 / 84065059		
	CNH	86517963		
	CNH	84441392	(piegato)	
	J. Deere	Z77601		
Deutz Fahr	1600 0617			



TRINCIAPAGLIA - STRAW CHOPPER KNIVES
STROHNACKSLERMESSER - COUTEAUX BROYEUR DE PAILLE
CUCHILLAS CORTARAJAS - НОЖИ СОЛОМОИЗМЕЛЬЧИТЕЛЯ

Codice Adattabili a: TRATT. TERMICO HEAT TREATMENT

TPML 50-5-18

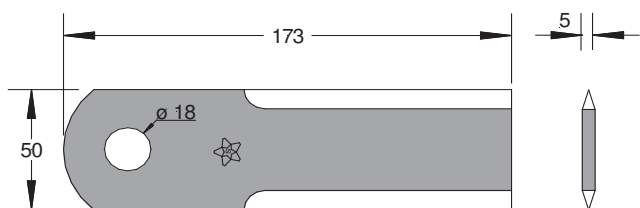

J. Deere

Z.42.176

Tagliante

Cutting

TPMS 50-5-18

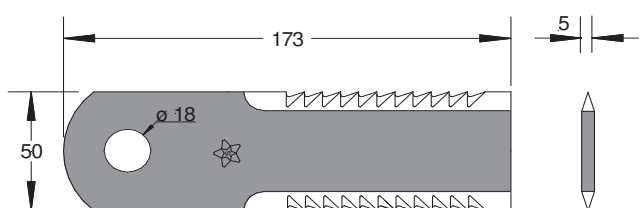

New Holland

84437624

Totale
Foro + tagliante

Total
Hole + cutting

TPMS TTL 50-4-18

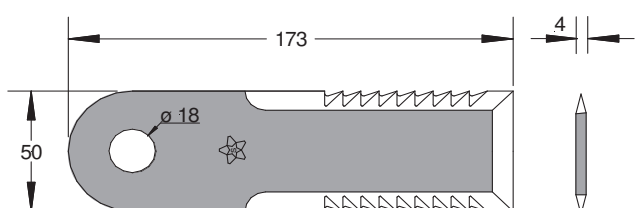

Laverda
New Holland

322326450

Foro + tagliante

Hole + cutting

TPMS TTS 50-4-18

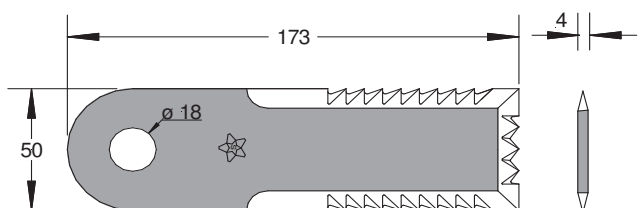

J. Deere Z.55.610
 Biso-Titanio 28274490000
 Biso 282740410000
 Biso 18173504
 Claas
 Laverda 322235450
 New Holland 89833966
 New Holland 84037550
 Deutz Fahr 160018725

Foro + tagliante Hole + cutting
 Foro + tagliante Hole + cutting
 Foro + tagliante Hole + cutting
 Foro + tagliante Hole + cutting
 Foro + tagliante Hole + cutting
 Foro + tagliante Hole + cutting
 Foro + tagliante Hole + cutting

TPML 50-3,5-20

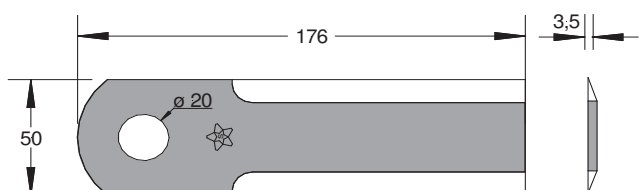

Rekord

41 348
40741348

Foro + tagliante

Hole + cutting



TRINCIAPAGLIA - STRAW CHOPPER KNIVES
STROHHACKSLERMESSER - COUTEAUX BROYEUR DE PAILLE
CUCHILLAS CORTARAJAS - НОЖИ СОЛОМОИЗМЕЛЬЧИТЕЛЯ

Codice	Adattabili a:	TRATT. TERMICO	HEAT TREATMENT
TPML 50-4,5-20			
	Rekord	44 280	Foro + tagliente
	Laverda	320999350	Totale
	New Holland	840196200	Hole + cutting
			Total

TPMS 50-4,5-20			
	Rekord		Foro + tagliente
	New Holland	84068444	Totale
	J. Deere	Z 75875	Hole + cutting
	M. Ferguson	49074600	Total

TPML 50-3-21			
	Lova	2209.0015-S1	Totale
			Total

TPML 50-3-18 L177			
	Laverda	2109	Totale
			Total

TPML 50-3-12			
	Claas	060.030.2	Tagliente
	Claas	060.030.0	Cutting
	J. Deere	Z.35.241	Tagliente
	Lova	2309.0045-S1	Totale
	Biso	41.001-121	Total
	Dronningborg	490 19000	
	Laverda	320706250 - 321722850	Tagliente
			Cutting



TRINCIAPAGLIA - STRAW CHOPPER KNIVES
STROHHACKSLERMESSER - COUTEAUX BROYEUR DE PAILLE
CUCHILLAS CORTARAJAS - НОЖИ СОЛОМОИЗМЕЛЬЧИТЕЛЯ

Codice	Adattabili a:	TRATT. TERMICO	HEAT TREATMENT	
TPMS 50-3-12				
	Claas	060 030.2 Z	Totale	Total
	Claas	0600302Z	Totale	Total
	Claas	737.600.0	Totale	Total

Codice	Adattabili a:	TRATT. TERMICO	HEAT TREATMENT	
CONTROCOLTELLO LISCIO				
	Biso	28.801.402- 0017	Totale	Total
	Biso	2809/3	Totale	Total
	New Holland	80 746 805	Totale	Total
	Deutz Fahr	0620-4848	Totale	Total
	J. Deere	Z.59.020	Totale	Total
	J. Deere	HXE13023	Totale	Total
	Dronningborg	490 18300	Totale	Total

Codice	Adattabili a:	TRATT. TERMICO	HEAT TREATMENT	
CONTROCOLTELLO DENTATO				
	Deutz Fahr	1600-0616	Totale	Total
	Biso	28.274-024	Totale	Total
	Biso	28.09/3 Z	Totale	Total
	J. Deere	Z.59.033	Totale	Total
	J. Deere	HXE13024	Totale	Total
	Laverda	322291650	Totale	Total
	Laverda	322235550	Totale	Total
	New Holland	89516450	Totale	Total

Codice	Adattabili a:	TRATT. TERMICO	HEAT TREATMENT	
CCL 40-3-10,4				
	Rekord	40151	Totale	Total
	Laverda	320997650		
	CNH	1322233C2		
	J. Deere	Z75874		

Codice	Adattabili a:	TRATT. TERMICO	HEAT TREATMENT	
CCS 40-3-10,4				
	Rekord	40151 Serrated	Totale	Total



TRINCIAPAGLIA - STRAW CHOPPER KNIVES
STROHHACKSLERMESSER - COUTEAUX BROYEUR DE PAILLE
CUCHILLAS CORTARAJAS - НОЖИ СОЛОМОИЗМЕЛЬЧИТЕЛЯ

Codice	Adattabili a:	TRATT. TERMICO	HEAT TREATMENT
---------------	----------------------	-----------------------	-----------------------

TPML 50-4-20

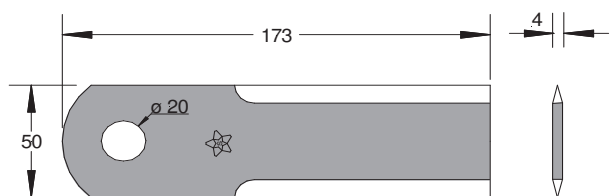

Claas	736 872.0
Claas	7368720

Foro + tagliente	Hole + cutting
Foro + tagliente	Hole + cutting

TPMS 50-4-20

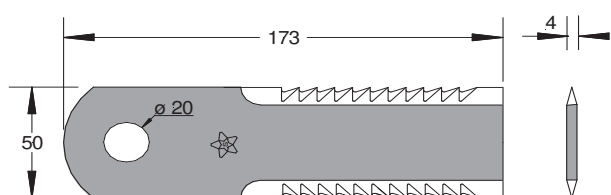

Claas	755.784.0
Claas	7557840

Foro + tagliente	Hole + cutting
Foro + tagliente	Hole + cutting

TPML TTL 50-4-20 + BOCCOLA

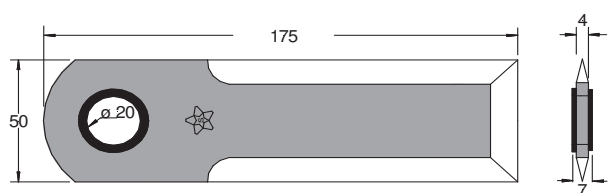

Claas	755 787.1
Claas	7557871

Tagliente	Cutting
Tagliente	Cutting

TPML 50-4-20 + BOCCOLA

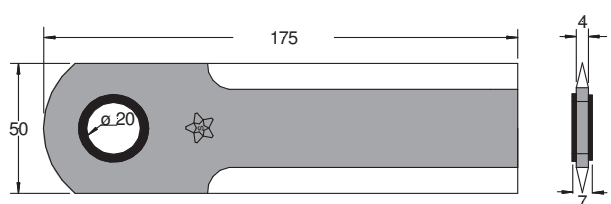

Claas	755 874.0
Claas	7558740

Tagliente	Cutting
Tagliente	Cutting

TPMS TTL 50-4-20 + BOCCOLA

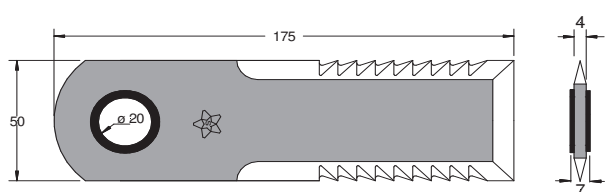

Claas	755.875
Claas	755875

Tagliente	Cutting
Tagliente	Cutting

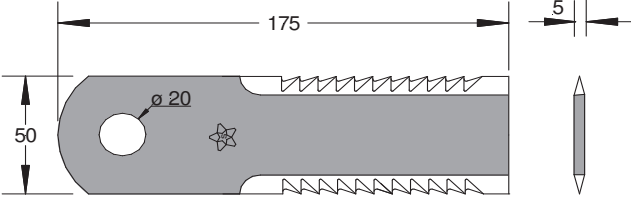
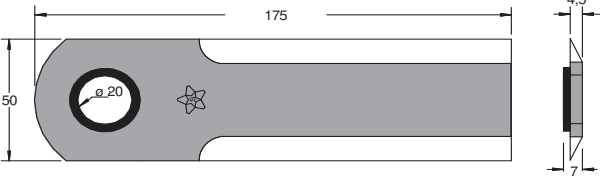
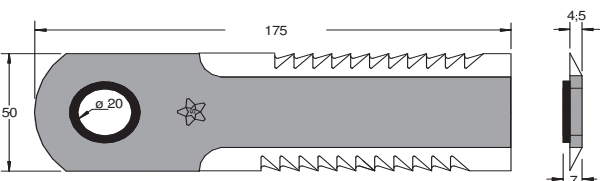
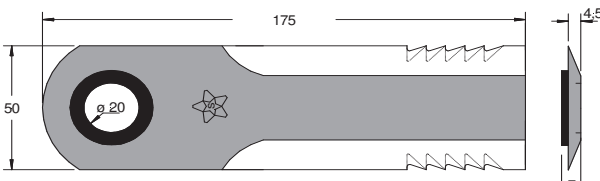
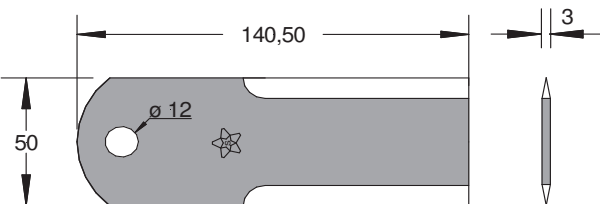

TRINCIAPAGLIA - STRAW CHOPPER KNIVES
STROHHACKSLERMESSER - COUTEAUX BROYEUR DE PAILLE
CUCHILLAS CORTAPAJAS - НОЖИ СОЛОМОИЗМЕЛЬЧИТЕЛЯ

Codice	Adattabili a:	TRATT. TERMICO	HEAT TREATMENT
TPMS 50-5-20			
	New Holland 87318316	Totale	Total
TPML 50-4,5-20 + BOCCOLA			
	CNH Rekord 1994760 C4 44443	Tagliente	Cutting
TPMS 50-4,5-20 + BOCCOLA			
	CNH 1994760 C4R	Tagliente	Cutting
TPMLS 50-4,5-20 + BOCCOLA			
	CNH 87593795	Tagliente	Cutting
TPML 50-3-12 L 140			
	New Holland New Holland 87318524 84437640	Totale	Total



TRINCIAPAGLIA - STRAW CHOPPER KNIVES
STROHNACKSLERMESSER - COUTEAUX BROYEUR DE PAILLE
CUCHILLAS CORTAPAJAS - НОЖИ СОЛОМОИЗМЕЛЬЧИТЕЛЯ

Codice

Adattabili a:

TPMS 50-3-14,5

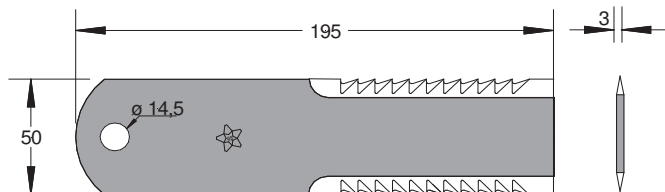

ST 92550 DX / ST 92551 SX

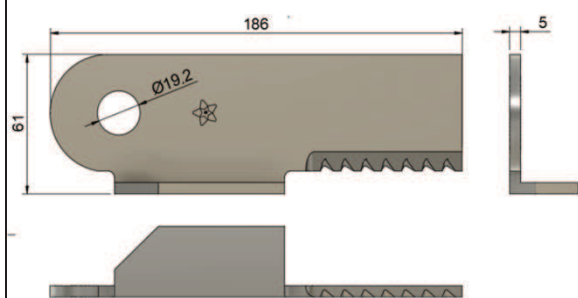

Versione DX

J. Deere	KXE 10363	Kit 4+4	NEW
J. Deere	KXE 10364	Kit 4+4	
J. Deere	KXE 10255	Kit 4+4	
J. Deere	AH 225937	Kit 4+4	
J. Deere	AH 213457	Kit 4+4	
J. Deere	AXE 92550	DX / RH	
J. Deere	AXE 92551	SX / LH	
J. Deere	H 218170	DX / RH	
J. Deere	H 218169	SX / LH	
J. Deere	H212700	DX / RH	(no hardface)
J. Deere	H212699	SX / LH	(no hardface)

TRINCIPIEG. DX / SX 18



Versione SX

New Holland	87031978	DX / RH	NEW
New Holland	87031976	SX / LH	

TRINCIPIEG. DX / SX 20

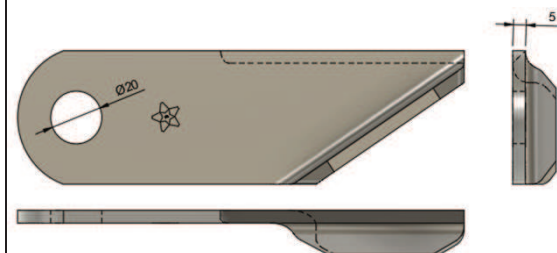

Versione SX

New Holland	87384920	DX / RH	NEW
New Holland	87384918	SX / LH	

TRINCIPIEG. 195 f.19,2 DX/SX

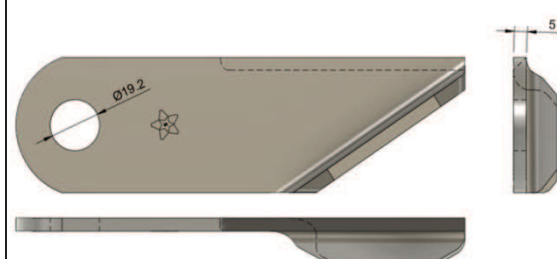

Versione SX

J. Deere	AH 205909	Kit 4+4	NEW
J. Deere	H 203894	DX / RH	
J. Deere	H 203895	SX / LH	



BOCCOLE - BUSHING
BUCHSEN - BAGUES - BUJE - ВТУЛКИ

Codice

Adattabili a:

Codice

Adattabili a:

BCL 3

Boccole per trinciapaglia sp.3 mm

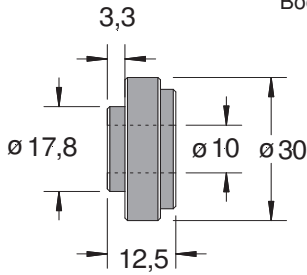

Deutz Fahr 06238559
 Bisio 28.801.405.0012/3
 J.Deere Z35216/3
 Claas
 New Holland 80746810

BCL 4

Boccole per trinciapaglia sp.4 mm

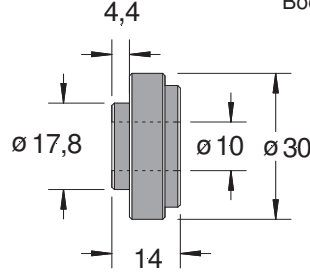

Deutz Fahr 06546848
 Bisio 28.801.405.012/4
 Bisio 28.203.068.000
 J.Deere Z51243/4
 Claas
 New Holland 80746732

BCLI 4,5

Boccole interna per trinc. sp. 4,5 mm

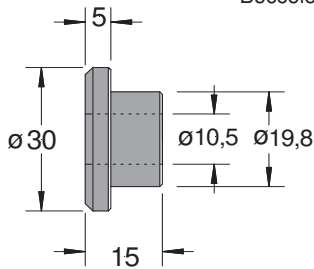

Cnh 1994758C2
 Jhc

BCLI 3

Boccole interna per trinc. sp. 3 mm

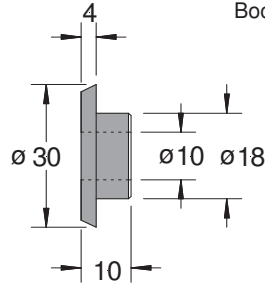

Claas 060.016.2

BCLI 4

Boccole interna per trinc. sp. 4 mm

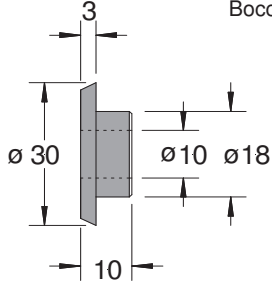

Claas 060.016

BCLE 3-4

Boccole esterna per trinc. sp. 3-4 mm

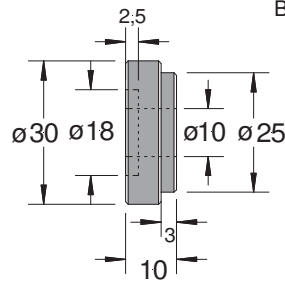

Claas 060.015

DIST 4

Distanziale

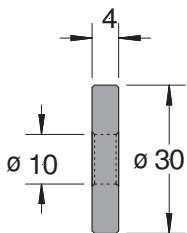

Deutz Fahr 06546849
 Bisio 28.801.405.0013
 Claas 736 870.1
 J.Deere Z 66313
 J.Deere Z 35217

BCL 5 f.18

Boccole per trinciapaglia sp.5 mm

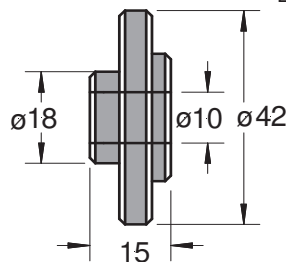

New Holland 84437622

BCL 5 f.20

Boccole per trinciapaglia sp.5 mm

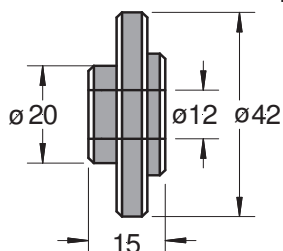

New Holland 87378123



BOCCOLE - BUSHING
BUCHSEN - BAGUES - BUJE - ВТУЛКИ

Codice

Adattabili a:

Codice

Adattabili a:



TRINCIASTOCCHI / TRINCIA MAIS COLTELLI TESTATA MAIS

www.stellalame.com

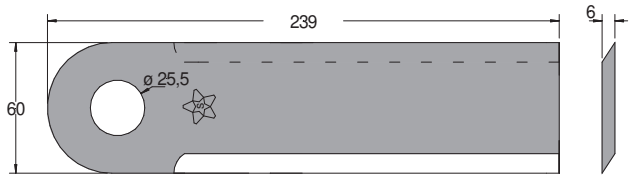
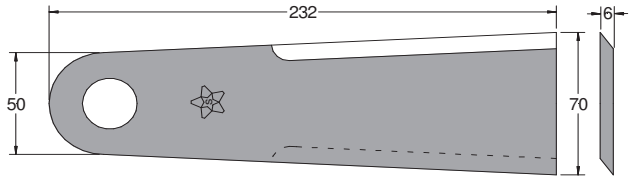
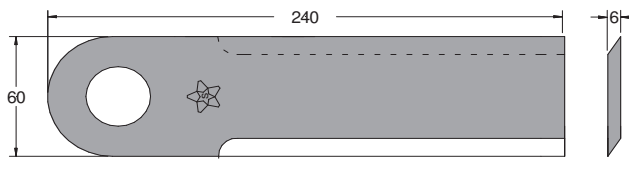
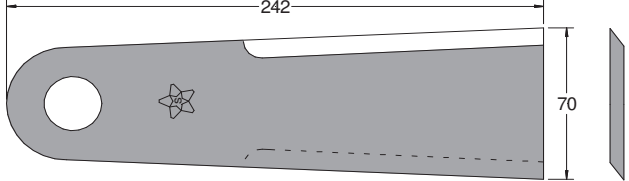
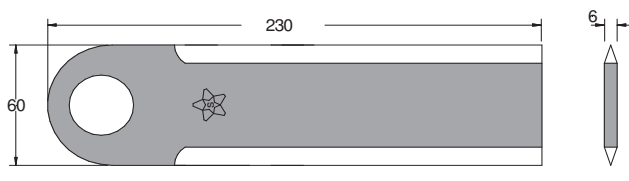

TRINCIASTOCCHI / TRINCIA MAIS - KNIVES FOR MAIZE
SCHELEGELMESSER FÜR MAIS - COUTEAUX POUR LE MAIS
CUCHILLAS PARA MAIS - НОЖИ КУКУРУЗНОЙ ЖАТКИ

Codice	Adattabili a:	TRATT. TERMICO	HEAT TREATMENT
TRINCIA 239		Capello mod. Diamante	Totale Total
TRINCIA 232		Capello 03202103	Totale Total
TRINCIA 240		Capello 03202100 mod. Quasar	Totale Total
TRINCIA 242		Capello	
TRINCIA 230			Totale Total



**TRINCIASTOCCHI / TRINCIA MAIS - KNIVES FOR MAIZE
SCHELEGELMESSER FÜR MAIS - COUTEAUX POUR LE MAIS
CUCHILLAS PARA MAIS - НОЖИ КУКУРУЗНОЙ ЖАТКИ**

Codice	Adattabili a:	TRATT. TERMICO	HEAT TREATMENT
TRINCIA 293			
	Fantini	13741	Totale Total
TRINCIA 260			
	Fantini	13739	Totale Total
TRINCIA 235			
	Fantini	21917	Totale Total
TRINCIA 233			
	Laverda New Holland	322593450	Totale Total
TRINCIA 230 CASE			
	Case / NH Case / NH New Holland	84976065 84976064 84340041	Totale Total Totale Total Totale Total



**TRINCIASTOCCHI / TRINCIA MAIS - KNIVES FOR MAIZE
SCHELEGELMESSER FÜR MAIS - COUTEAUX POUR LE MAIS
CUCHILLAS PARA MAIS - НОЖИ КУКУРУЗНОЙ ЖАТКИ**

Codice Adattabili a: TRATT. TERMICO HEAT TREATMENT

TRINCIA 250 CLAAS

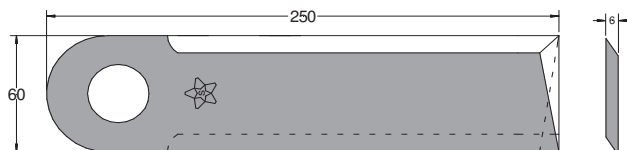

Claas	998683.0	Totale	Total
Claas	994233.0	Totale	Total

TRINCIA 220

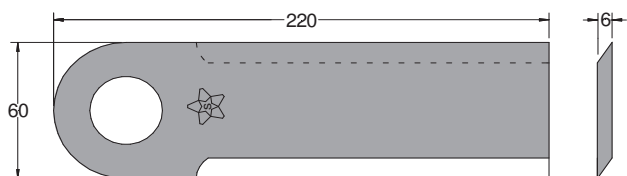

Oros	1310741	Totale	Total
Oros	1.310.741	Totale	Total

ALTRI MODELLI

Geringhoff	502692 - 502675
Geringhoff	502840 - 502841
Geringhoff	506035 - 506282
Fantini	13739
Oros	1319929
Oros	11-045258
Olimac	DR12300
DBF	271060030
Kemper	LCA 86215 - 8145



TRINCIASTOCCHI / TRINCIA MAIS - KNIVES FOR MAIZE
SCHELEGELMESSER FÜR MAIS - COUTEAUX POUR LE MAIS
CUCHILLAS PARA MAIS - НОЖИ КУКУРУЗНОЙ ЖАТКИ

Codice

Adattabili a:

TRATT.
TERMICO

HEAT
TREATMENT

SCK 87106692

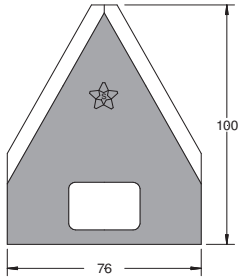

CNH

87106692

Totale

Total

LTM 448-65-6

Lama testata mais

New Holland

322426950

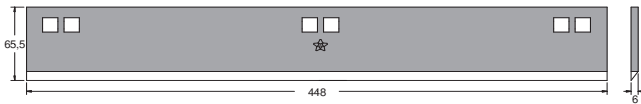

LTM 488-66-6

Lama testata mais

CNH

322591950

Laverda

322591950

New Holland

84433810

New Holland

86628054

New Holland

84976542

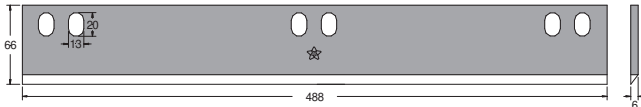

LTM 543-54-6

Lama testata mais

New Holland

80457477

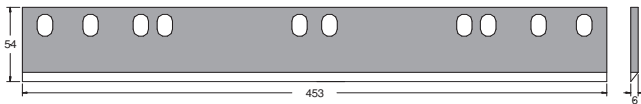

LTM 457-56-6

Lama testata mais

CNH

1327126C1

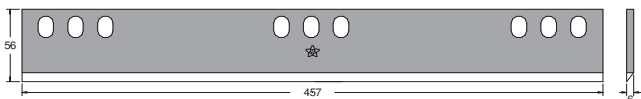

**TRINCIASTOCCHI / TRINCIA MAIS - KNIVES FOR MAIZE
SCHELEGELMESSER FÜR MAIS - COUTEAUX POUR LE MAIS
CUCHILLAS PARA MAIS - НОЖИ КУКУРУЗНОЙ ЖАТКИ**

Codice

Adattabili a:

TRATT.
TERMICO

HEAT
TREATMENT

LTM 400-63-6		
Lama testata mais	Capello	03.4100.00 - 03410000

LTM 530-60-6		
Lama testata mais	Fantini	12133

ALTRI MODELLI		
Lame testata mais	Geringhoff	502350 - 502356 (DX)
	Geringhoff	502351 - 502357 (SX)
	Capello	03.2019.00 (Mod. Quasar)
	Fantini	03950
	Fantini	4099
	Olimac	DR11030
	Oros	11-060584
	Oros	19-045060

--	--	--



COLTELLI PER CANNA DA ZUCCHERO

www.stellalame.com



COLTELLI PER CANNA DA ZUCCHERO
CHOPPER KNIVES SUGAR CANE - COUTEAUX POUR LA CANNE À SUCRE
MESSER FÜR ZUCKERROHR
CUCHILLAS DE CAÑA DE AZUCAR - LÂMINAS DE CANA DE AÇÚCAR
НОЖИ МАШИНЫ ДЛЯ УБОРКИ САХАРНОГО ТРОСТНИКА

Codice:

Adattabili a:

TRATT.
TERMICO

HEAT
TREATMENT

BCB 267-90-5

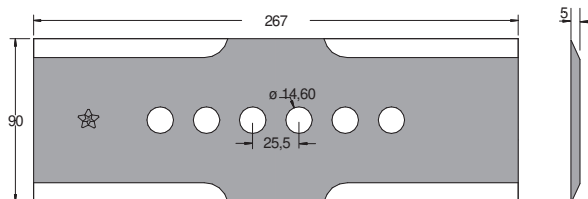

Case 448928A1

Specifico

Specific

Altri modelli su richiesta

Coltello per canna da zucchero / Base cutter blades / Chopper knife sugar cane harvester / Chucillas de caña de azucar

CB 845-8

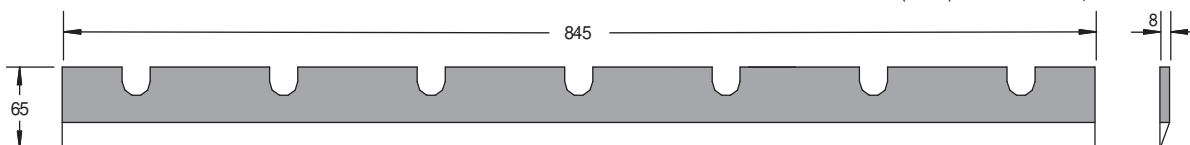

Case 47430491 (sost.87214899)

Specifico

Specific

Case 87214899 (h.65)

Specifico

Specific

J. Deere 243005174 (h.95)

Specifico

Specific



LAME PER CARRI DESILATORI

www.stellalame.com

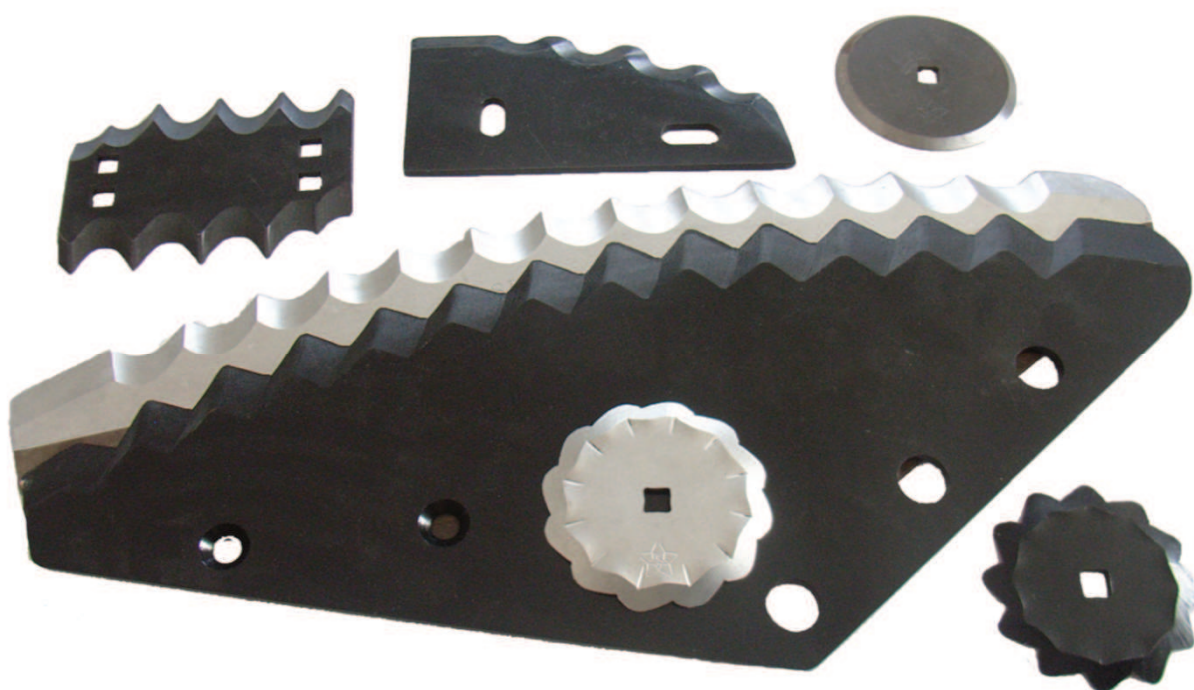

LAME PER CARRI DESILATORI - BLADES FOR SHREDDER MIXER
KLINGEN FÜR SILOSENLADER - LAMES POUR EXTRACTEUR MELANGEURS
CUCHILLAS DESMENUZADORAS PARA CARROS MEZCLADORES
НОЖИ ДЛЯ МИКСЕРОВ-КОРМОРАЗДАТЧИКОВ

Codice

Adattabili a:

Codice

Adattabili a:

D2001 L f.6,25

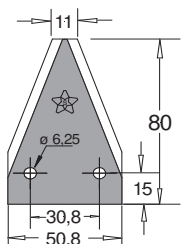

Liscia
 Spess. 2,5
 Varie
 Storti 1680008
 Mutti
 Luclar
 Feraboli
 DeLaval

D2001 L f.6,25 P

** L'angolo di piegatura può essere realizzato su richiesta

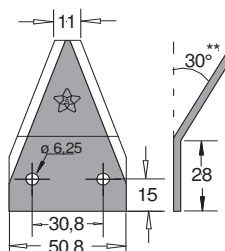

Liscia
 Spess. 2,5
 Varie
 Mutti
 DeLaval

D2001 L x 3 f.6,25

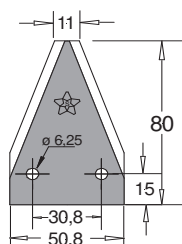

Liscia
 Spess. 3
 Sgariboldi
 Luclar
 Varie

D2001 L x 3 f.6,25 P

** L'angolo di piegatura può essere realizzato su richiesta

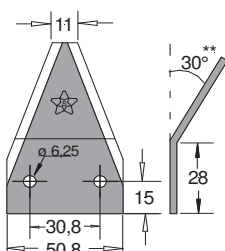

Liscia
 Spess. 3
 Luclar
 Varie

D2001 L x 3 f.6,25 DX

** L'angolo di piegatura può essere realizzato su richiesta

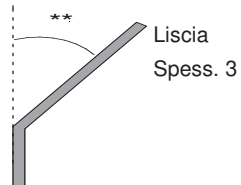
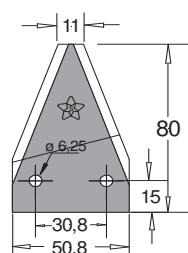

Liscia
 Spess. 3
 Varie

D2001 L x 3 f.6,25 SX

** L'angolo di piegatura può essere realizzato su richiesta

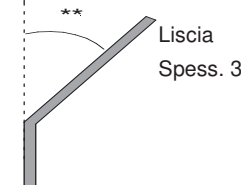
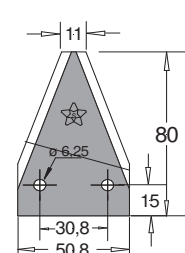

Liscia
 Spess. 3
 Varie

D2001 S f.6,25

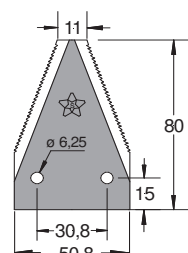

Sotto rigata
 Spess. 2,5
 Varie

D2001 S x 3 f.6,25

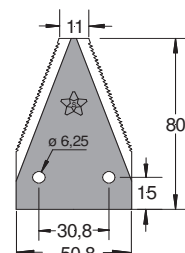

Sotto rigata
 Spess. 3
 Varie

D2001 S x 3 f.8,5

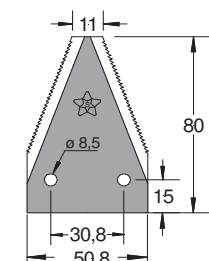

Sotto rigata
 Spess. 3
 Varie

D2001 L 6 fori

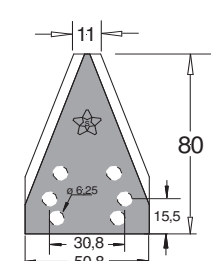

Liscia
 Spess. 2,5
 DeLaval 94832801
 Storti 1680002600



LAME PER CARRI DESILATORI - BLADES FOR SHREDDER MIXER
KLINGEN FÜR SILOSENLADER - LAMES POUR EXTRACTEUR MELANGEURS
CUCHILLAS DESMENUZADORAS PARA CARROS MEZCLADORES
НОЖИ ДЛЯ МИКСЕРОВ-КОРМОРАЗДАТЧИКОВ

Codice

Adattabili a:

Codice

Adattabili a:

D2001 S x 3 f.8,5 DX

** L'angolo di piegatura può essere realizzato su richiesta

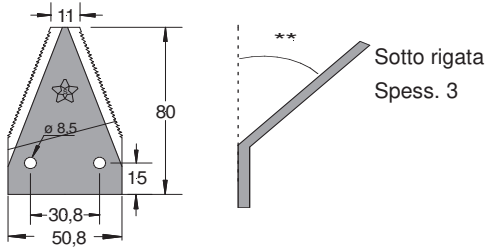

Sotto rigata
Spess. 3

D2001 S x 3 f.8,5 SX

** L'angolo di piegatura può essere realizzato su richiesta

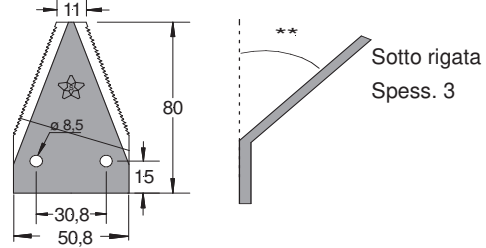

Sotto rigata
Spess. 3

89x3 L

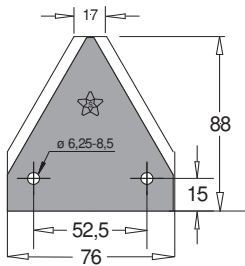

Liscia
Spess.3

Varie
Faresin (fori diam. 8,5)
Comag - Sgariboldi (fori diam. 6,25)

89x3 L P

** L'angolo di piegatura può essere realizzato su richiesta

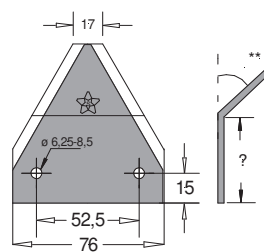

Liscia
Spess.3

Varie
Comag (fori diam. 6,25)

89x4 L

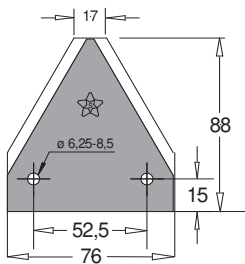

Liscia
Spess. 4

Faresin

89x4 L P

** L'angolo di piegatura può essere realizzato su richiesta

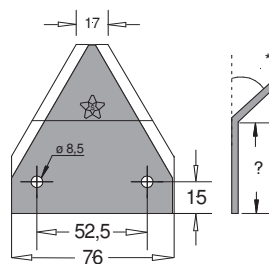

Liscia
Spess. 4

Faresin

89x3 S

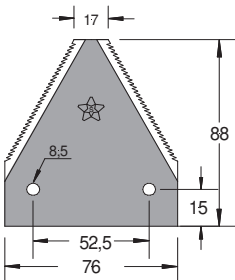

Sotto rigata
Spess.3

Varie

89x3 S P

** L'angolo di piegatura può essere realizzato su richiesta

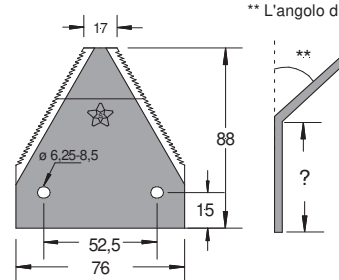

Sotto rigata
Spess.3

Varie

89x3 L f.6,25 P

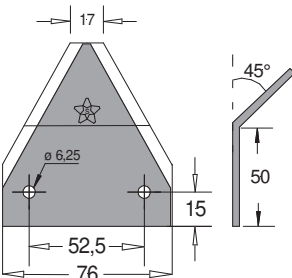

Liscia
Spess.3

Varie
Sgariboldi

89x3 L f.8,5 P

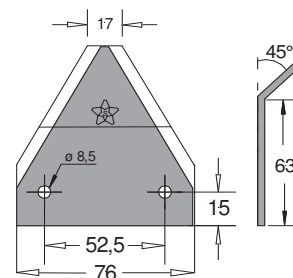

Liscia
Spess.3

Varie
Faresin



LAME PER CARRI DESILATORI - BLADES FOR SHREDDER MIXER
KLINGEN FÜR SILOSENLADER - LAMES POUR EXTRACTEUR MELANGEURS
CUCHILLAS DESMENUZADORAS PARA CARROS MEZCLADORES
НОЖИ ДЛЯ МИКСЕРОВ-КОРМОРАЗДАТЧИКОВ

Codice

Adattabili a:

Codice

Adattabili a:

89x3 L f.10,5 P 22

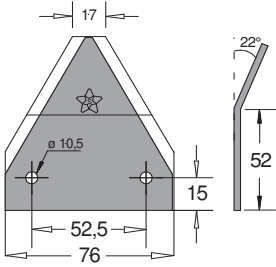

Liscia
Spess.3

Varie

89x3 L f.10,5 P 34

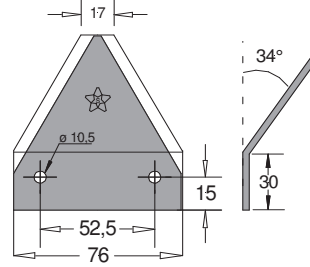

Liscia
Spess.3

Varie

89x3 L Dx - Sx

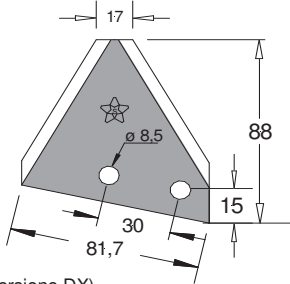

Liscia
Spess. 3 / 4

AGM
Unifast

(versione DX)

D2001L FUX

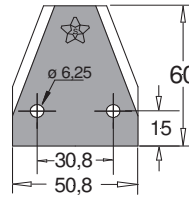

Liscia
Spess.2,5

AGM

212x3 L f.8,5

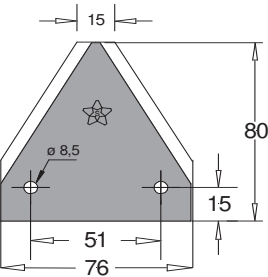

Liscia
Spess.3

212x3 L f.8,5 pieg.

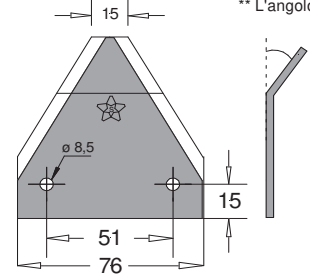

** L'angolo di piegatura può essere realizzato su richiesta

Liscia
Spess.3

212x3 L f.6,5

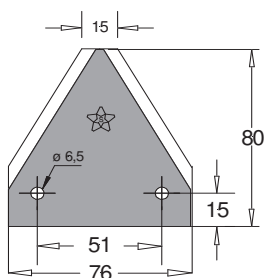

Liscia
Spess. 3

Kuhn A7153002
Varie

212x3 L f.6,5 pieg.

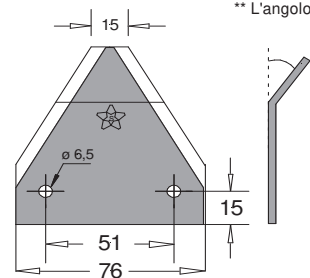

** L'angolo di piegatura può essere realizzato su richiesta.

Liscia
Spess. 3

Kuhn A7153001
Varie

363

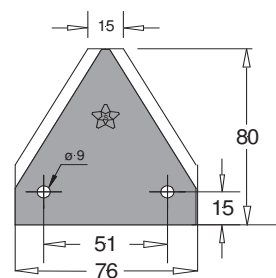

Liscia
Spess. 3

Marmix

362

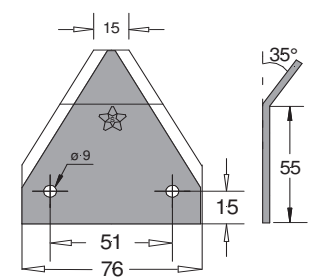

Liscia
Spess. 3

Marmix



LAME PER CARRI DESILATORI - BLADES FOR SHREDDER MIXER
KLINGEN FÜR SILOSENLADER - LAMES POUR EXTRACTEUR MELANGEURS
CUCHILLAS DESMENUZADORAS PARA CARROS MEZCLADORES
НОЖИ ДЛЯ МИКСЕРОВ-КОРМОРАЗДАТЧИКОВ

Codice

Adattabili a:

Codice

Adattabili a:

242 P dx - sx

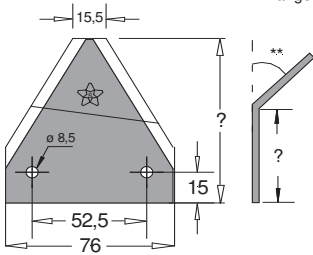

** L'angolo di piegatura può essere realizzato su richiesta

Liscia / sotto rigata
Spess.3

Seko 24479055 DX
Seko 24479056 SX

ROTOMIX SR

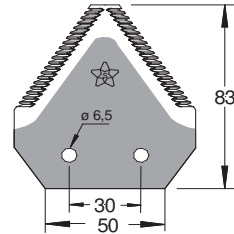

Sopra rigata
Spess. 2,7

Rotomix

ST 3001



Liscia
Spess.4

NEW

Storti 16800150
Storti 1680003001 (con riporto)

ROTOMIX S

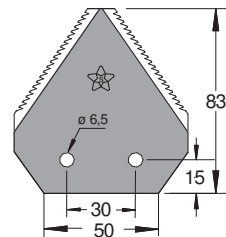

Sotto rigata
Spess. 2,7

Kuhn A7153021

ST 0029

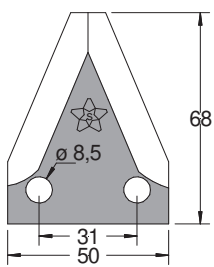

NEW

Storti 16800029

ST 0129

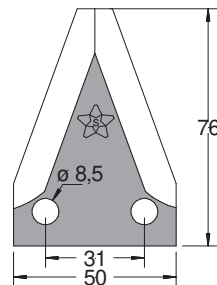

NEW

Storti 16800129

ST 7153021

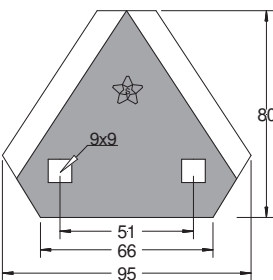

Liscia
Spess.4

NEW

Kuhn A7153021

ST604206 P60° TN

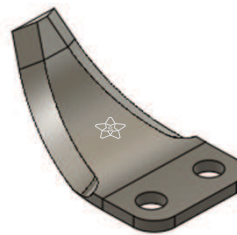

NEW

Siloking 604206

ST 704229



NEW

Silage excluding

Keenan 704229

ST 1350 TN

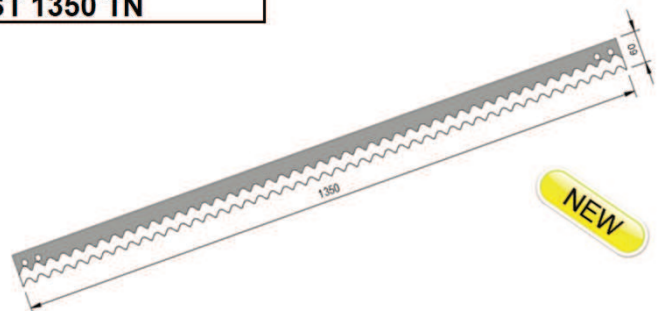

NEW

Guaresi 19078



LAME PER CARRI DESILATORI - BLADES FOR SHREDDER MIXER
KLINGEN FÜR SILOSENLADER - LAMES POUR EXTRACTEUR MELANGEURS
CUCHILLAS DESMENUZADORAS PARA CARROS MEZCLADORES
НОЖИ ДЛЯ МИКСЕРОВ-КОРМОРАЗДАТЧИКОВ

Codice

Adattabili a:

Codice

Adattabili a:

DISCO 95

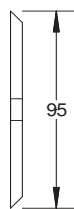

Spess. 5
 Foro 11 x 11 Sgariboldi
 Himel 3001689
 Pagliari - Marmix
 Luclar - Eurocomp
 Supertino - Tatoma
 Storti 1680020
 Frasto 16800020 - Walker
 DeLaval 94832401

DISCO DENTATO 95



Spess. 5
 Foro 11 x 11
 Himel
 Tatoma
 Storti 16800014
 Frasto 16800014 - Walker
 Kverneland

DISCO DENTATO SK

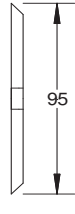

Spess. 5
 Foro 11 x 11

DISCO DENTATO SK - diam.140

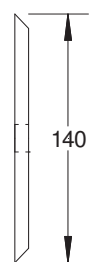
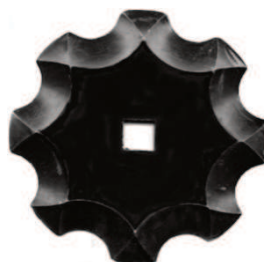

Spess. 8
 Foro 16,5 x 16,5

COLTELLO OVALE DENTATO



Spess. 5

Storti 16800139

DISCO MARGHERITA diam. 95



Spess. 5
 Foro 11 x 11

Varie

ALETTA DX-SX

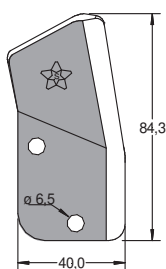

Spess. 3
 Foro Ø 6,5

(versione SX)

Storti 16800012-13

ALETTA DX-SX

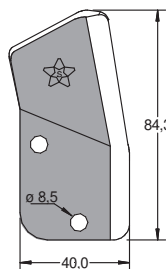

Spess. 4
 Foro Ø 8,5

(versione SX)

CM 0001 SX

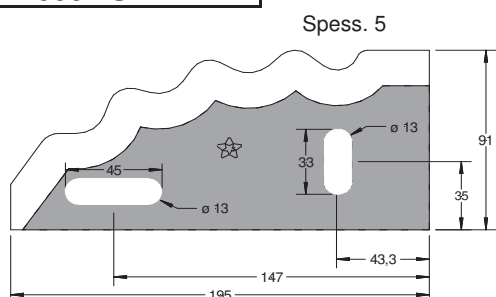

Peecon
 Himel
 Luclar
 Giglioli
 Frasto
 Pagliari

CM 0001 DX

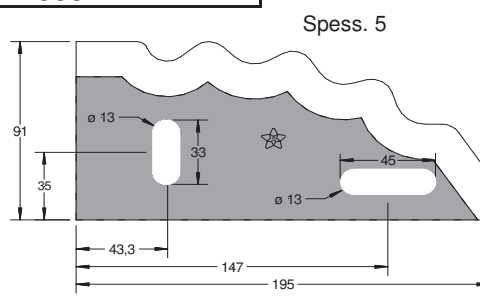

Peecon
 Himel
 Luclar
 Giglioli
 Frasto
 Pagliari



LAME PER CARRI DESILATORI - BLADES FOR SHREDDER MIXER
KLINGEN FÜR SILOSENLADER - LAMES POUR EXTRACTEUR MELANGEURS
CUCHILLAS DESMENUZADORAS PARA CARROS MEZCLADORES
НОЖИ ДЛЯ МИКСЕРОВ-КОРМОРАЗДАТЧИКОВ

Codice

Adattabili a:

Codice

Adattabili a:

CM 0001 / L 180 SX

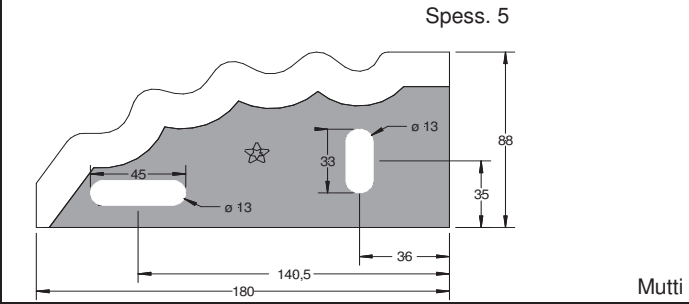

Mutti

CM 0001 / L 180 DX

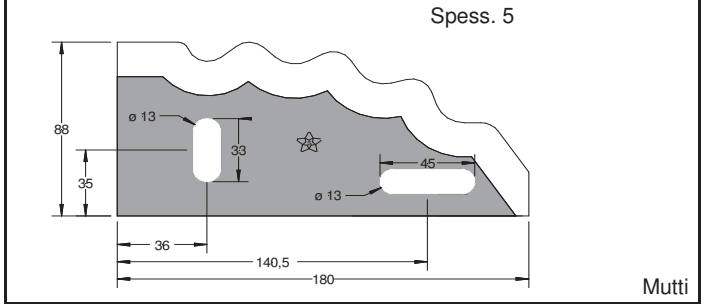

Mutti

CM 0003 SX

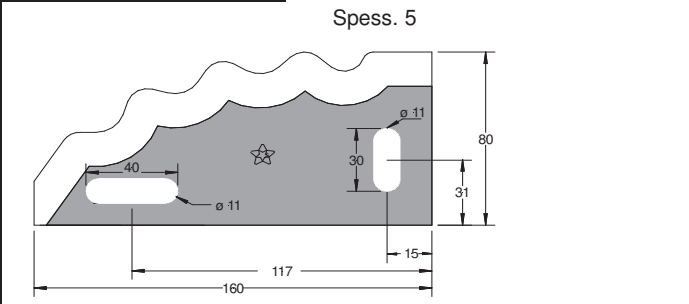

CM 0003 DX

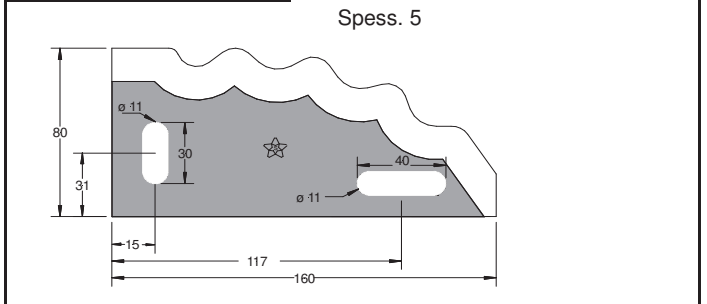

CM 0006 SX

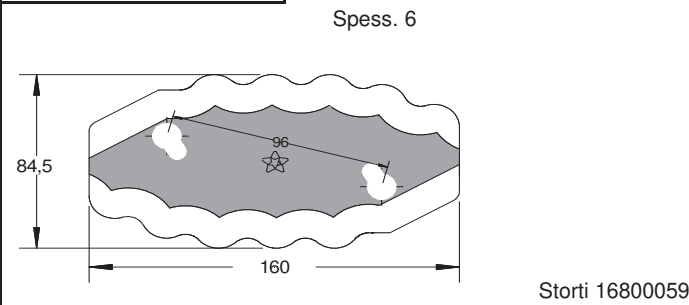

Storti 16800059

CM 0006 DX

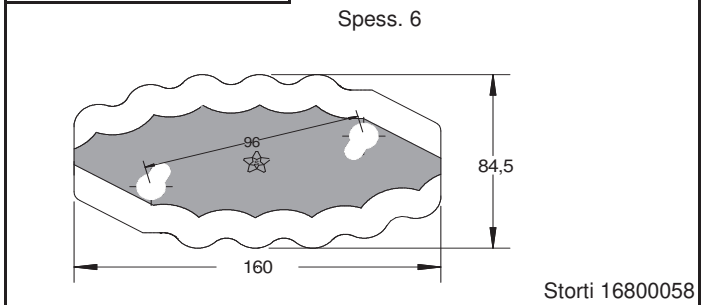

Storti 16800058

ST 0061

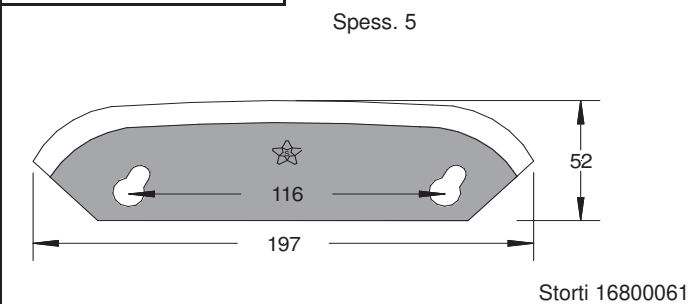

Storti 16800061

ST 00160

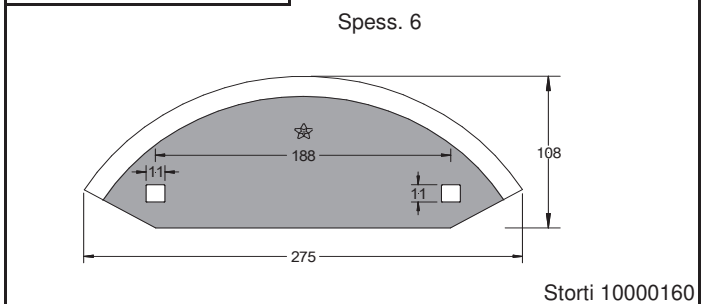

Storti 10000160

ST 00133

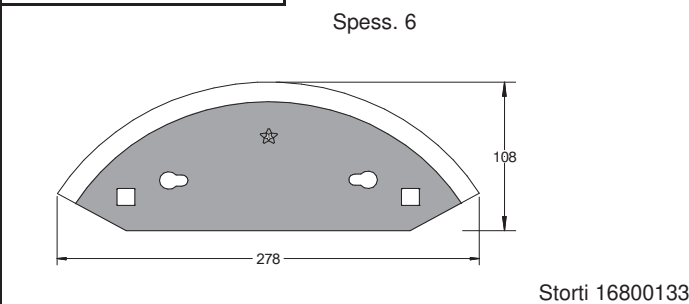

Storti 16800133

CMF 20

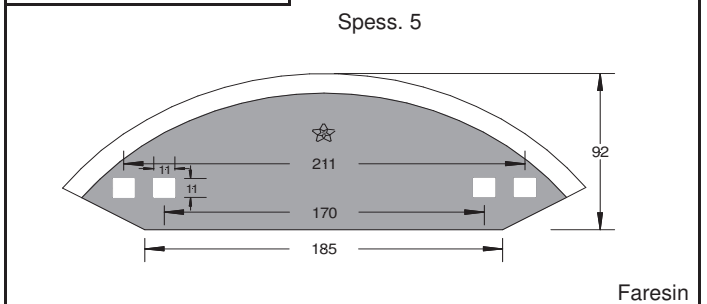

Faresin



LAME PER CARRI DESILATORI - BLADES FOR SHREDDER MIXER
KLINGEN FÜR SILOSENLADER - LAMES POUR EXTRACTEUR MELANGEURS
CUCHILLAS DESMENUZADORAS PARA CARROS MEZCLADORES
НОЖИ ДЛЯ МИКСЕРОВ-КОРМОРАЗДАТЧИКОВ

Codice

Adattabili a:

Codice

Adattabili a:

CMF 0021 SX

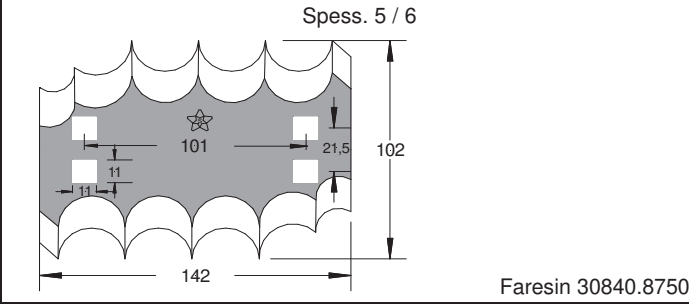

Faresin 30840.8750

CMF 0021 DX

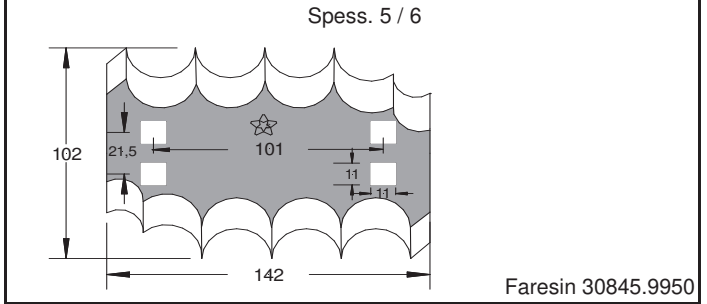

Faresin 30845.9950

CMS 0005 SX

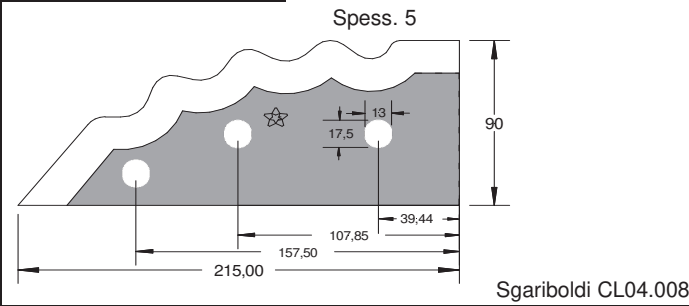

Sgariboldi CL04.008

CMS 0005 DX

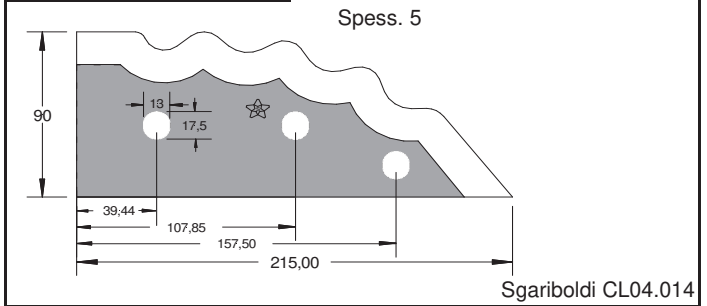

Sgariboldi CL04.014

CM 0002

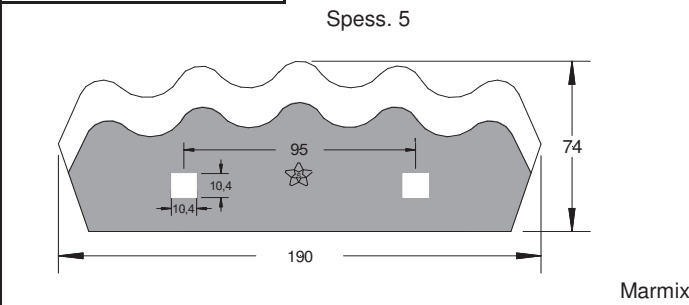

Marmix

CM 0008

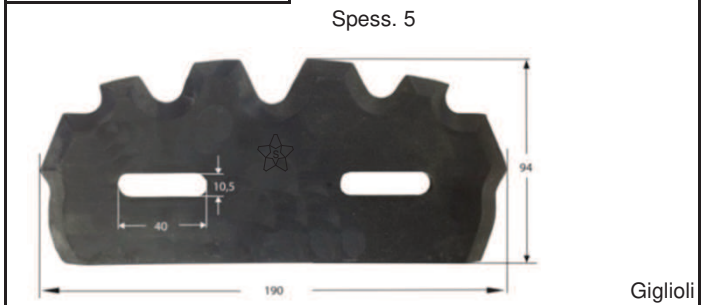

Giglioli

CM 0009 T

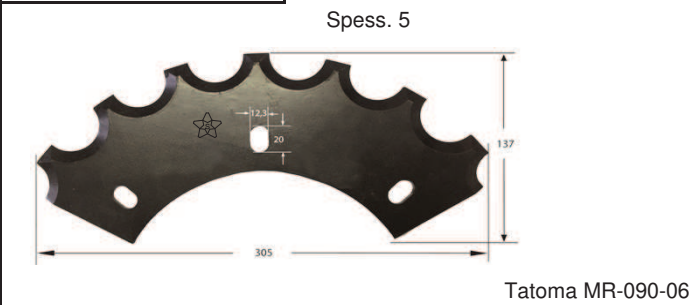

Tatoma MR-090-06

ST 703954 SX



Keenan 703955
Keenan 703954

ST 703955 DX

ST 703956 SX

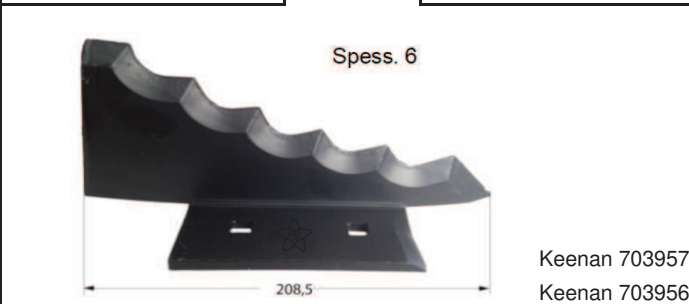

Keenan 703957
Keenan 703956

ST 703957 DX

ST 701359 SX

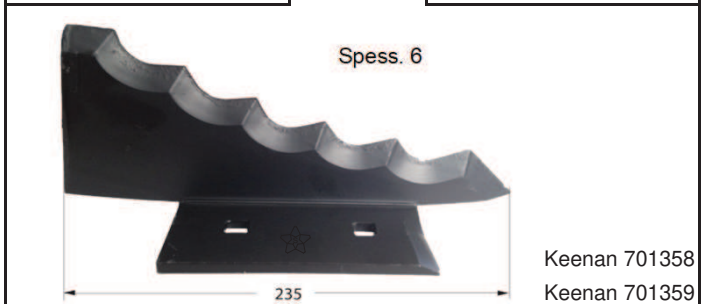

Keenan 701358
Keenan 701359

ST 701358 DX



LAME PER CARRI DESILATORI - BLADES FOR SHREDDER MIXER
KLINGEN FÜR SILOSENLADER - LAMES POUR EXTRACTEUR MELANGEURS
CUCHILLAS DESMENUZADORAS PARA CARROS MEZCLADORES
НОЖИ ДЛЯ МИКСЕРОВ-КОРМОРАЗДАТЧИКОВ

Codice

Adattabili a:

Codice

Adattabili a:

RRC 210x220

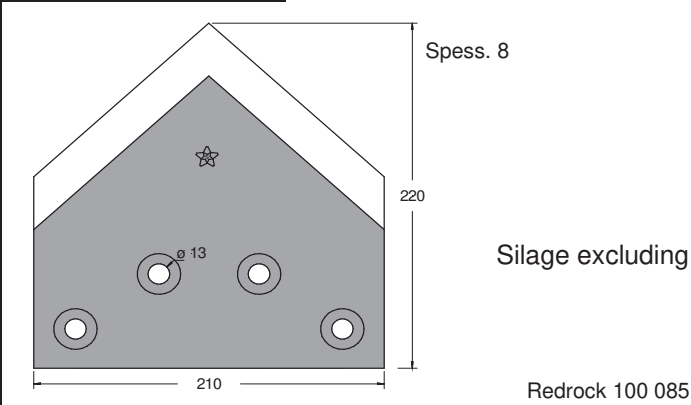

RRS 160x220

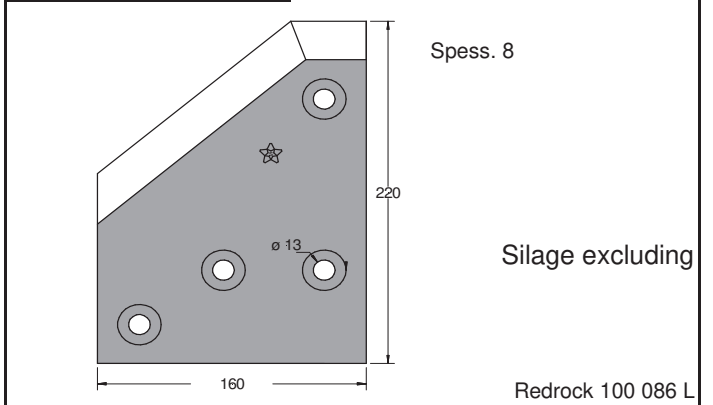

RRD 160x220

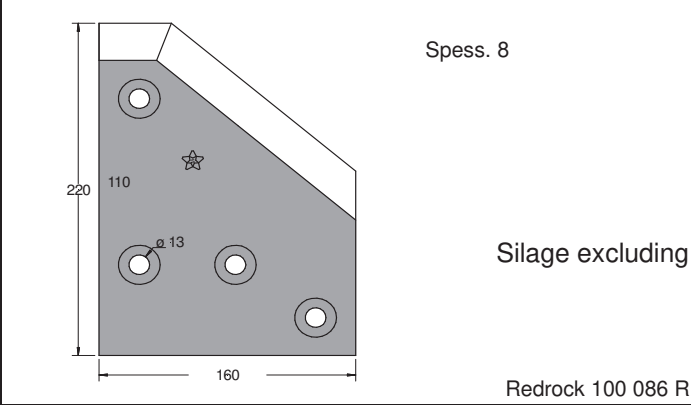

COLTELLO TR



ST 7153012

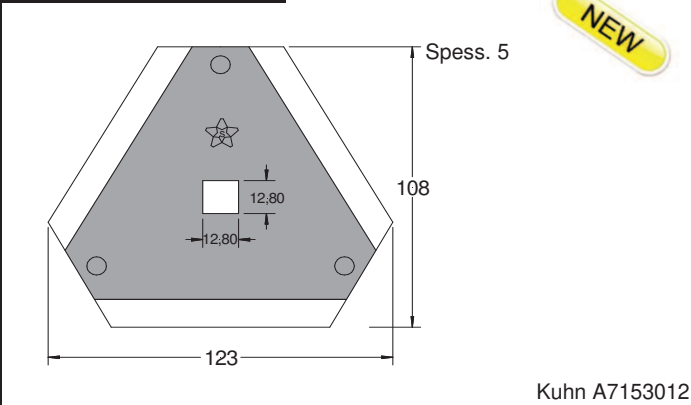

ST 5306460

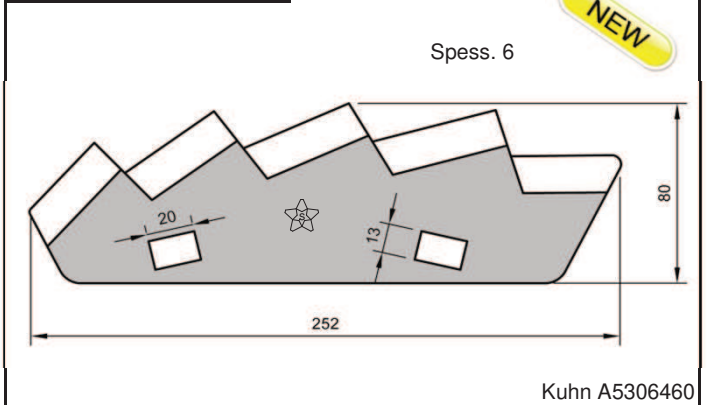

STR 2001

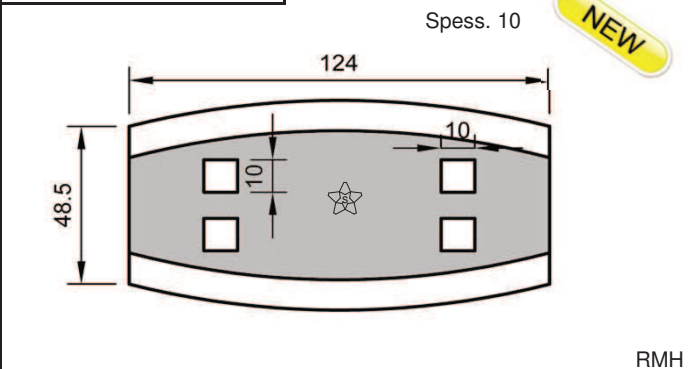

ST 5310403

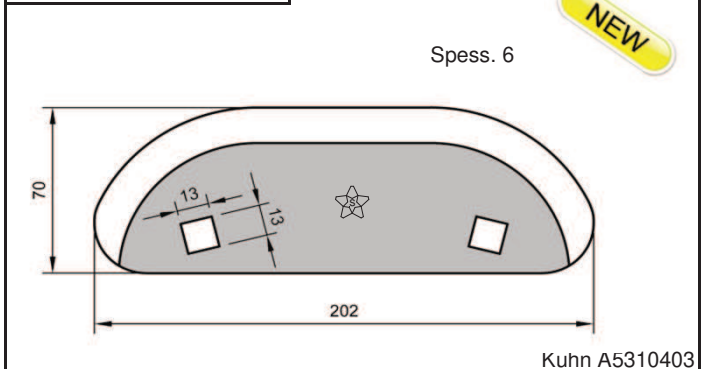

LAME PER CARRI DESILATORI - BLADES FOR SHREDDER MIXER
KLINGEN FÜR SILOSENLADER - LAMES POUR EXTRACTEUR MELANGEURS
CUCHILLAS DESMENUZADORAS PARA CARROS MEZCLADORES
НОЖИ ДЛЯ МИКСЕРОВ-КОРМОРАЗДАТЧИКОВ

Codice

Adattabili a:

Codice

Adattabili a:

CMV 0004 - Platinum

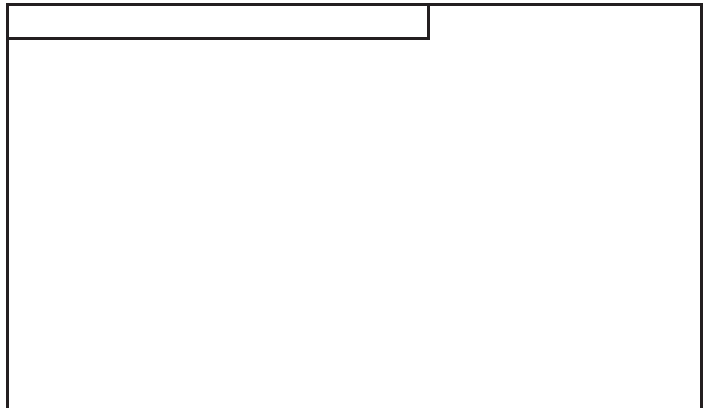

CMV 0007 SX - Standard

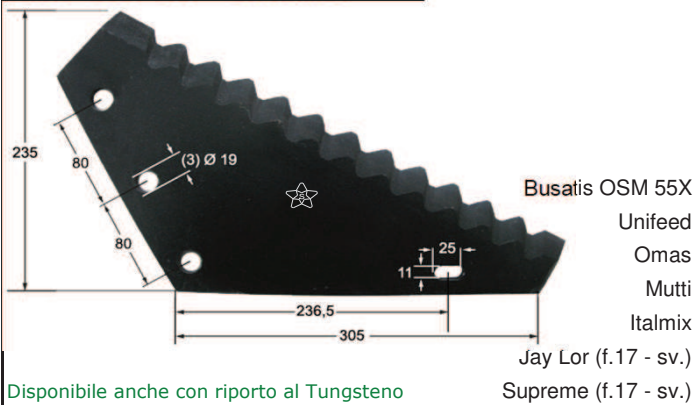

CMV 0007 DX - Standard

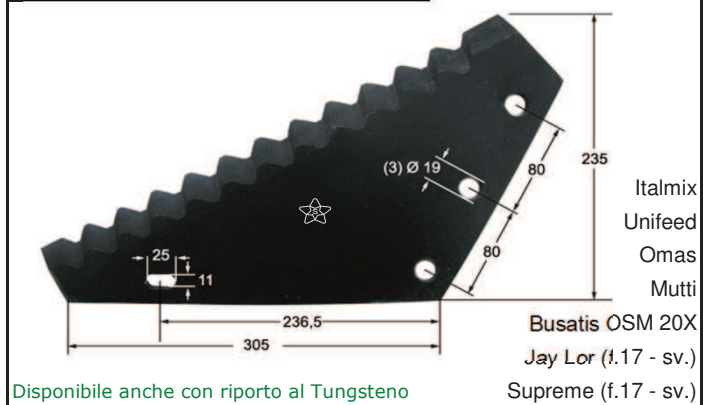

CMV 0007 SX - Platinum

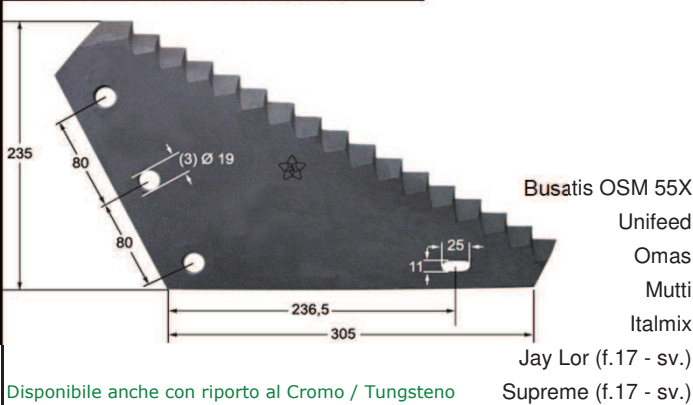

CMV 0007 DX - Platinum

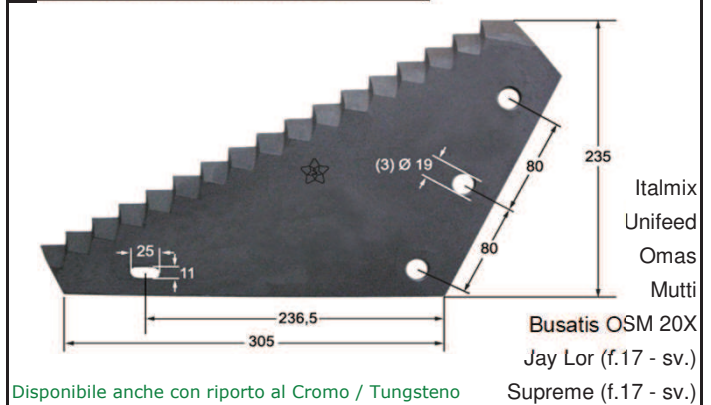

CMV 0009 SX - Standard

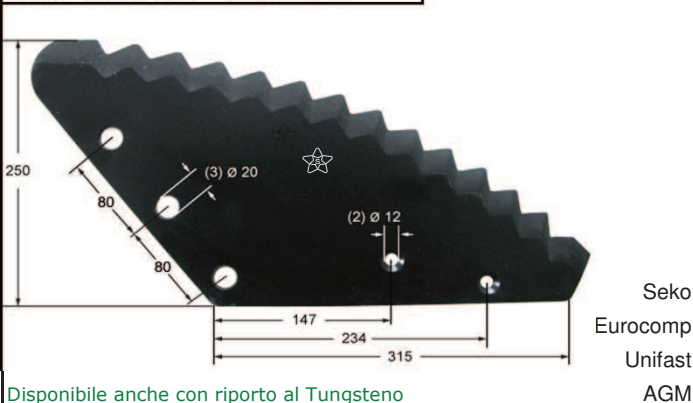

CMV 0009 DX - Standard



LAME PER CARRI DESILATORI - BLADES FOR SHREDDER MIXER
KLINGEN FÜR SILOSENLADER - LAMES POUR EXTRACTEUR MELANGEURS
CUCHILLAS DESMENUZADORAS PARA CARROS MEZCLADORES
НОЖИ ДЛЯ МИКСЕРОВ-КОРМОРАЗДАТЧИКОВ

Codice

Adattabili a:

Codice

Adattabili a:

CMV 0009 SX - Platinum

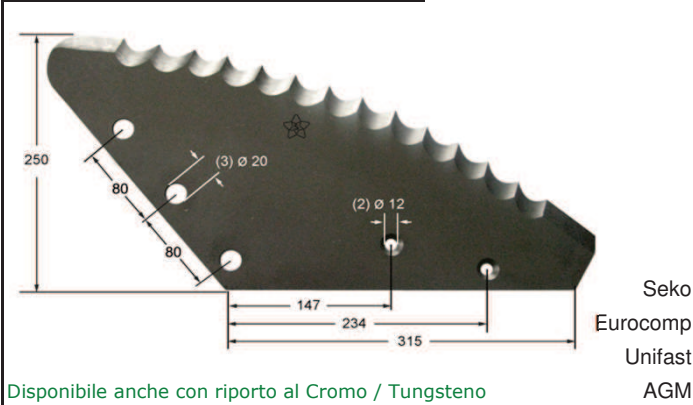

CMV 0009 DX - Platinum

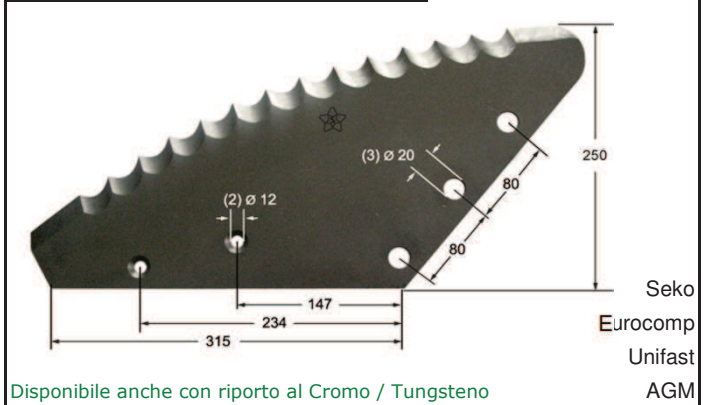

CMV 0010 SX - Standard

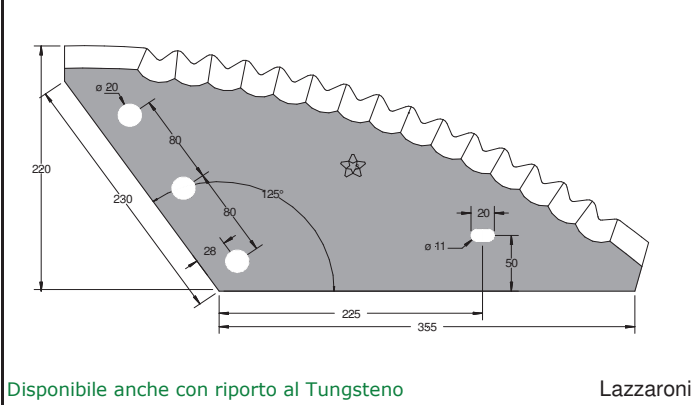

CMV 0010 DX - Standard

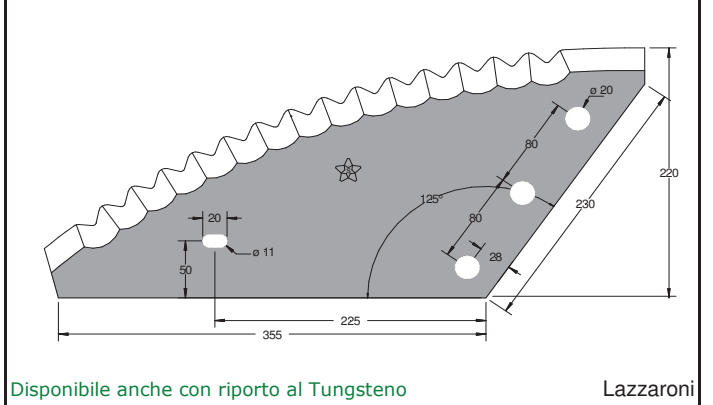

CMV 0011 SX - Platinum

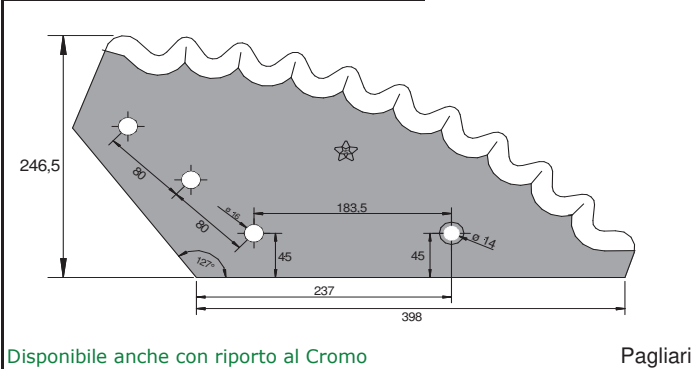

CMV 0011 DX - Platinum

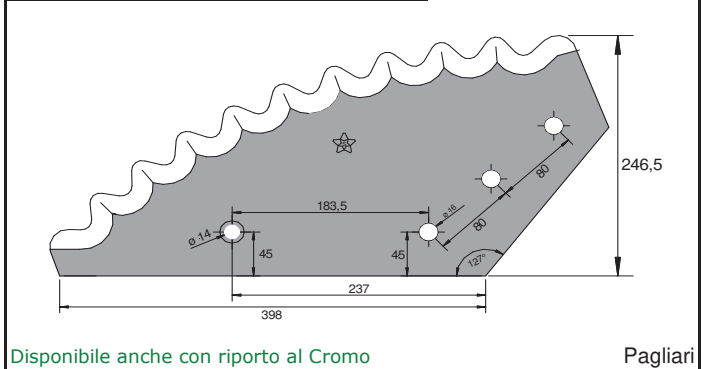

CMV 0012 - Platinum

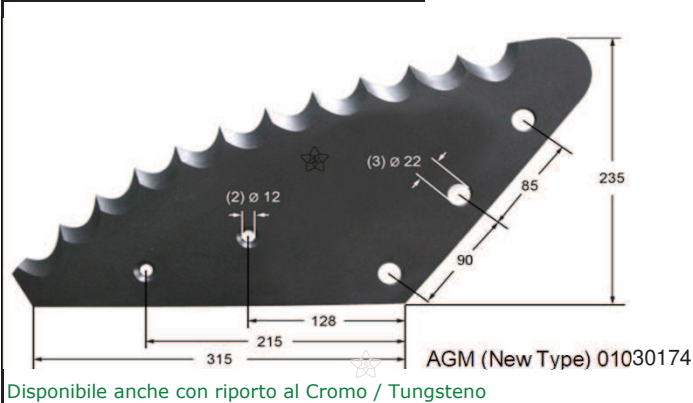

CMV 0015

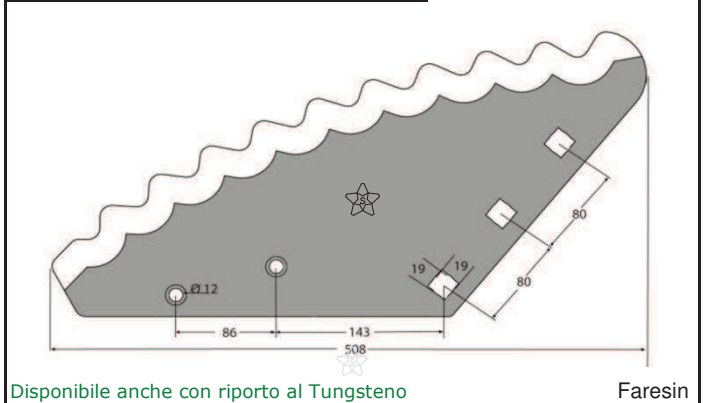

LAME PER CARRI DESILATORI - BLADES FOR SHREDDER MIXER
KLINGEN FÜR SILOSENLADER - LAMES POUR EXTRACTEUR MELANGEURS
CUCHILLAS DESMENUZADORAS PARA CARROS MEZCLADORES
НОЖИ ДЛЯ МИКСЕРОВ-КОРМОРАЗДАТЧИКОВ

Codice

Adattabili a:

Codice

Adattabili a:

CMV 0014 SX - Standard



Disponibile anche con riporto al Tungsteno

Supertino

CMV 0014 DX - Standard



Disponibile anche con riporto al Tungsteno

Supertino

CMV 0016

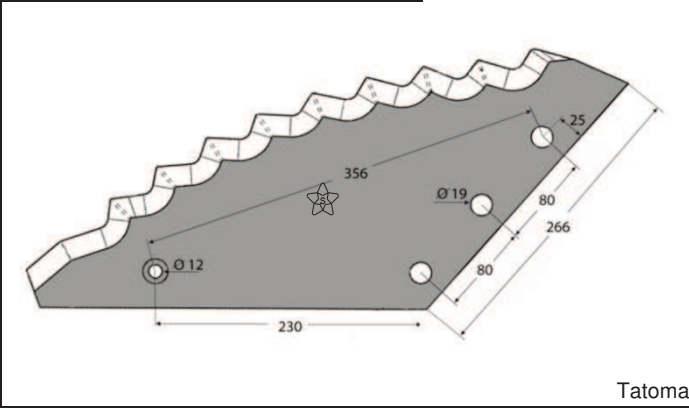

Tatoma

CMV 0018

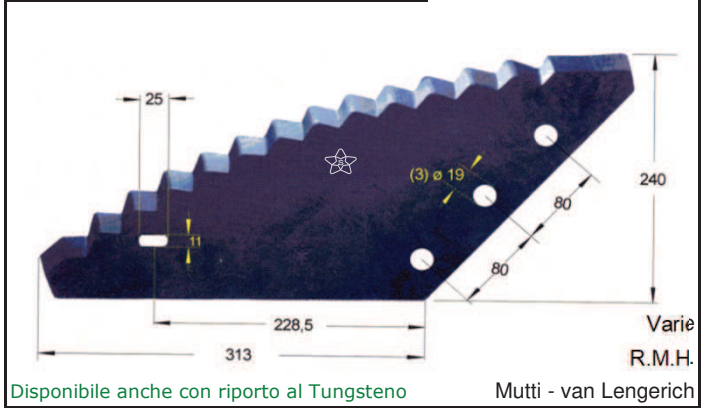

Disponibile anche con riporto al Tungsteno

Varie R.M.H. Mutti - van Lengerich

CMV 0019

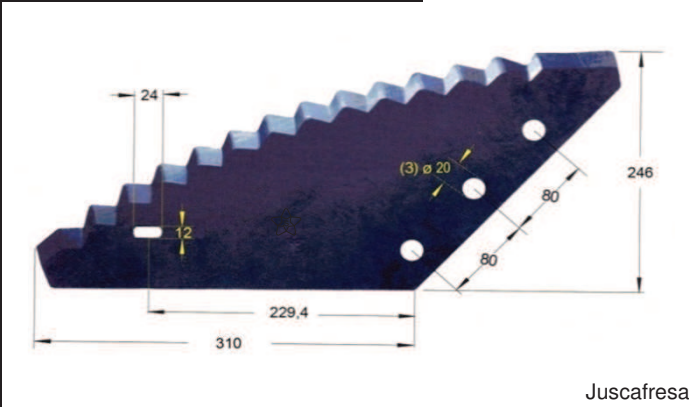

Juscafresa

CMV 0020

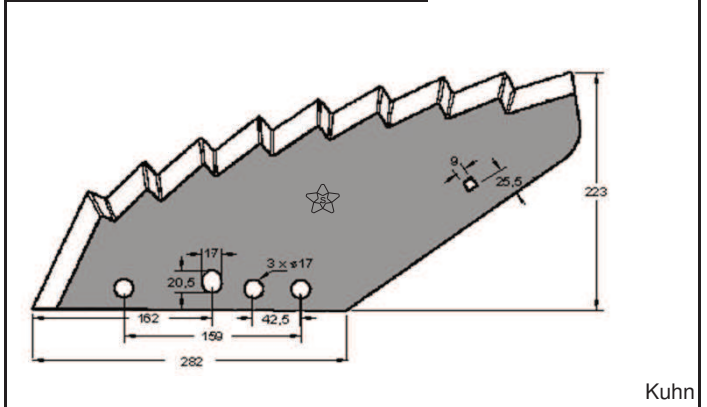

Kuhn

CMV 0021

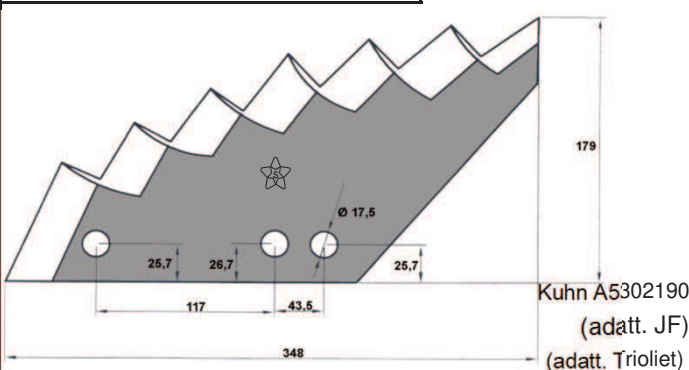

Kuhn A5302190
(adatt. JF)
(adatt. Trioliet)

CMV 0022

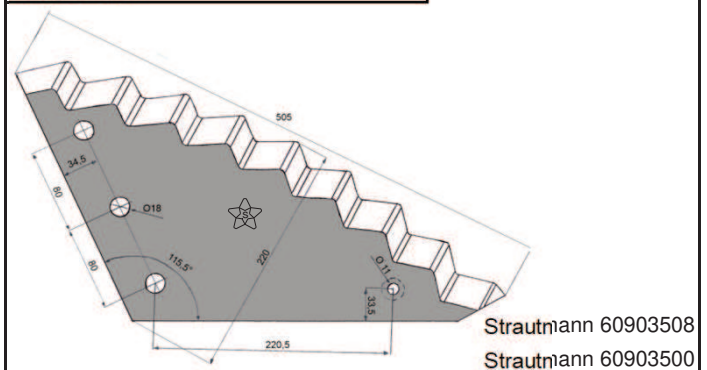

Strautmann 60903508
Strautmann 60903500



LAME PER CARRI DESILATORI - BLADES FOR SHREDDER MIXER
KLINGEN FÜR SILOSENLADER - LAMES POUR EXTRACTEUR MELANGEURS
CUCHILLAS DESMENUZADORAS PARA CARROS MEZCLADORES
НОЖИ ДЛЯ МИКСЕРОВ-КОРМОРАЗДАТЧИКОВ

Codice

Adattabili a:

Codice

Adattabili a:

CMV 0023

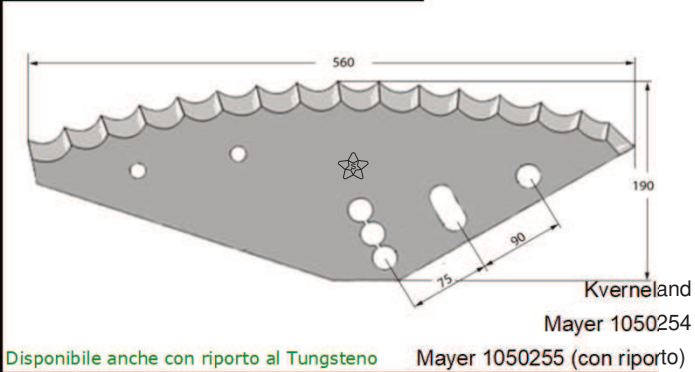

Disponibile anche con riporto al Tungsteno Mayer 1050255 (con riporto)

CMV 0023 JEANTIL

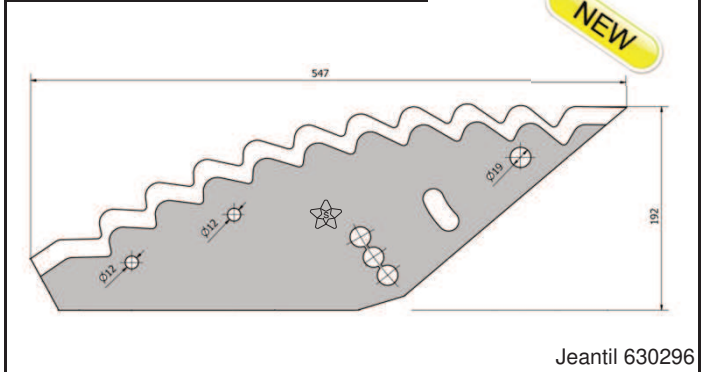

Jeantil 630296

CMV 0024

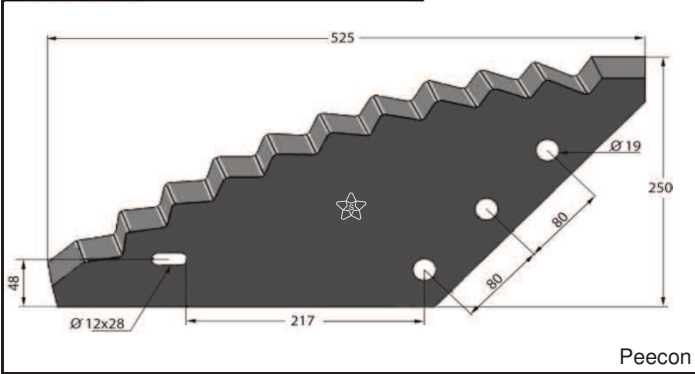

Peecon

CMV 0025 TN

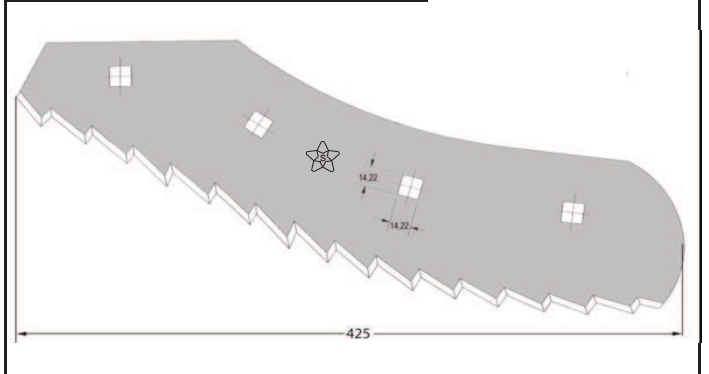

Con riporto al Tungsteno

Jay Lor

CMV 0026 TN

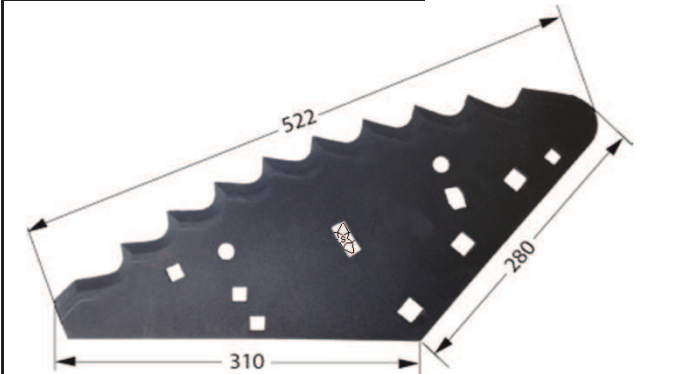

Con riporto al Tungsteno

Penta

CMV 0027

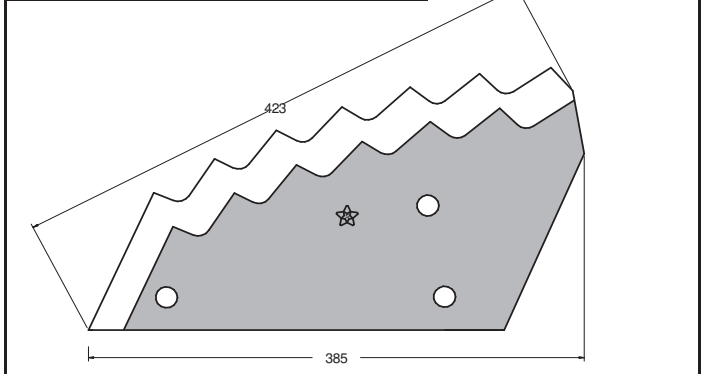

Kuhn 006-70147065

CMV 0028

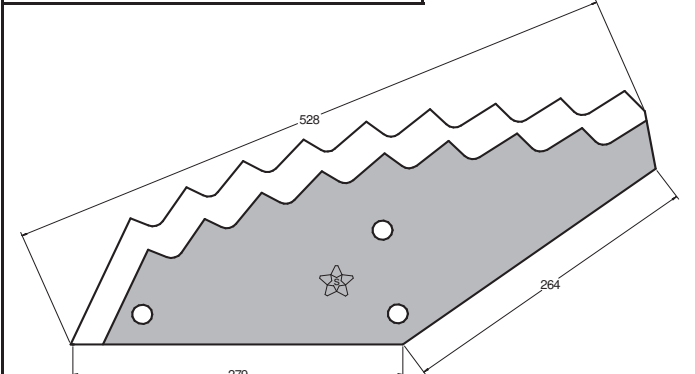

Kuhn 023-70144734

CMV 0029

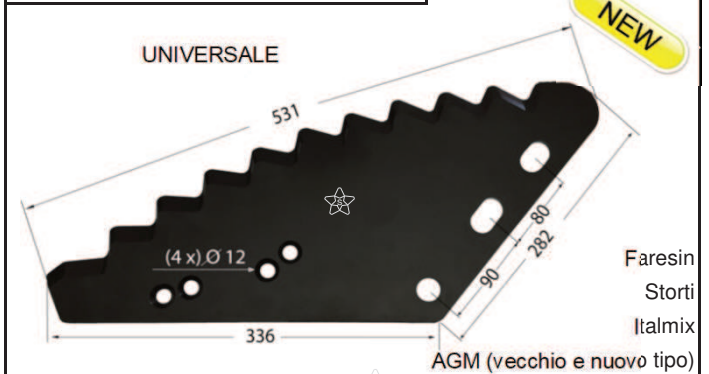

Disponibile anche con riporto al Cromo / Tungsteno

General Mix



LAME PER CARRI DESILATORI - BLADES FOR SHREDDER MIXER
KLINGEN FÜR SILOSENLADER - LAMES POUR EXTRACTEUR MELANGEURS
CUCHILLAS DESMENUZADORAS PARA CARROS MEZCLADORES
НОЖИ ДЛЯ МИКСЕРОВ-КОРМОРАЗДАТЧИКОВ

Codice

Adattabili a:

Codice

Adattabili a:

CMV 00155



ST 16200

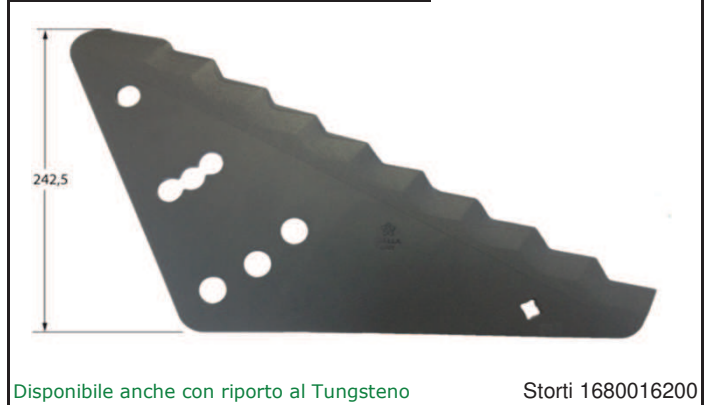

CMV 0035

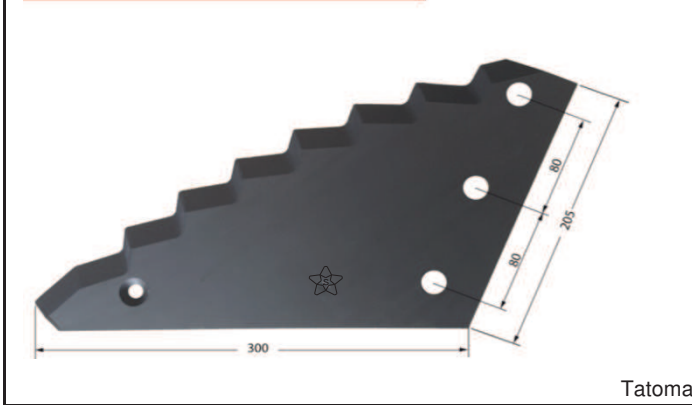

CMV 0046 TN

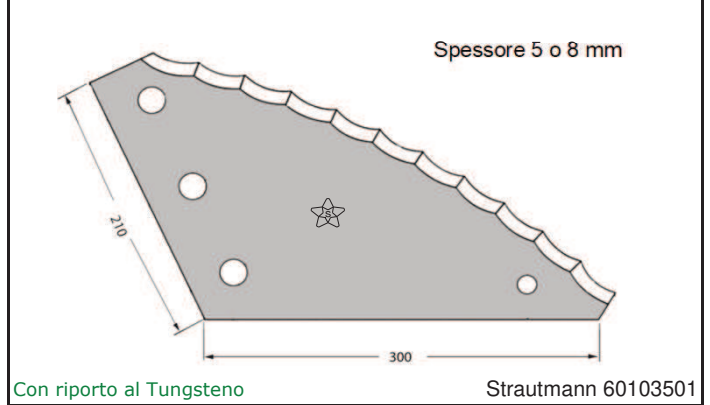

CMV 0047

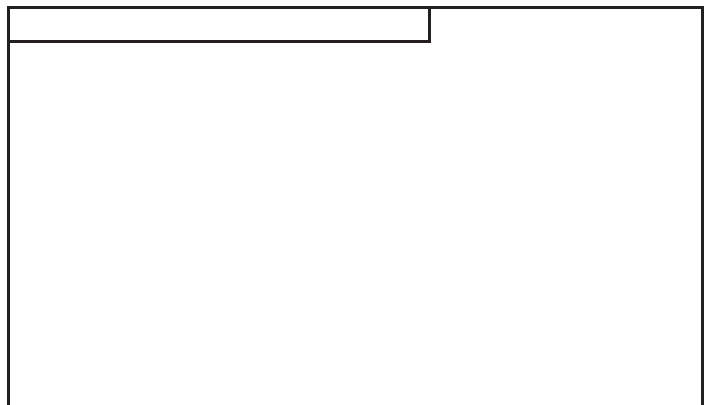
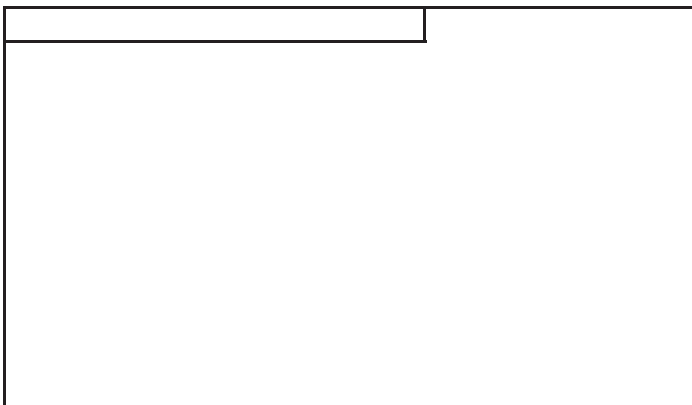
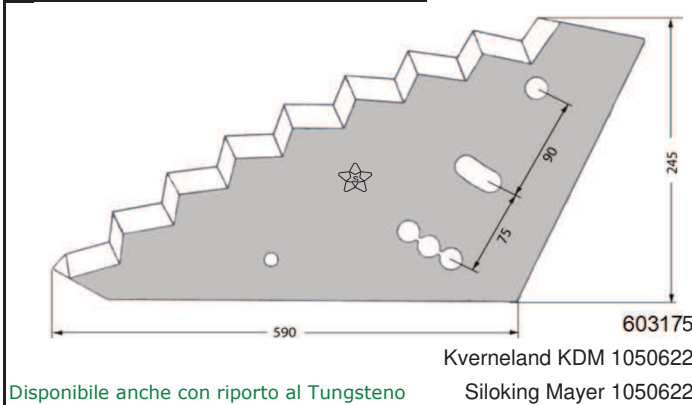

COLTELLI PER ROTOPRESSE / AUTOCARICANTI

www.stellalame.com



COLTELLI PER ROTOPRESSE- KNIVES FOR ROUND BALERS
COUTEAUX POUR PRESSES DES BALLES CYLINDRIQUES - MESSER FÜR BALLENPRESSEN
CUCHILLAS ROTOEMPACADORA - НОЖИ ДЛЯ ПРЕСС-ПОДБОРЩИКА

Codice

Adattabili a:

Codice

Adattabili a:

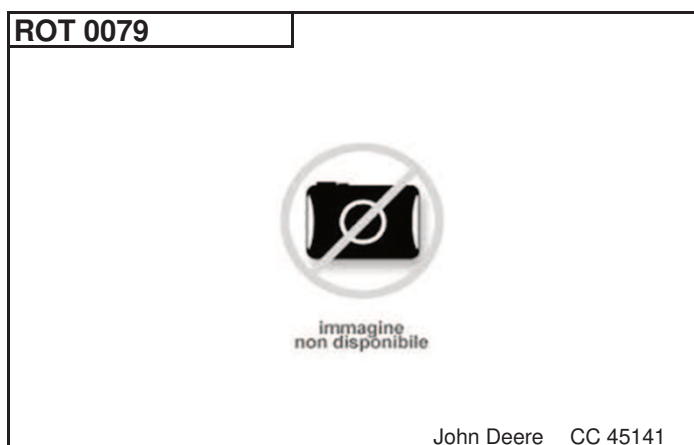
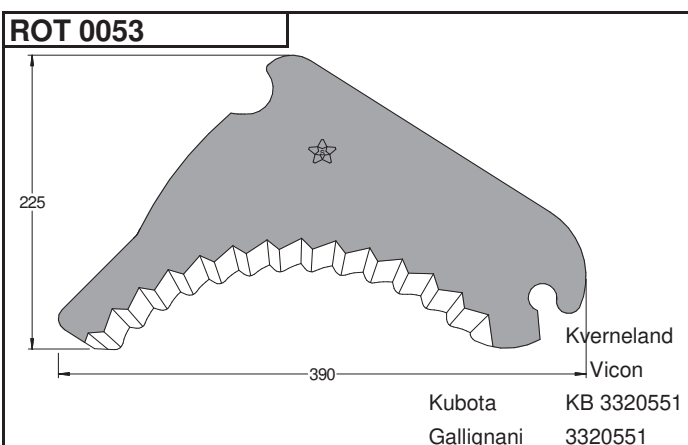
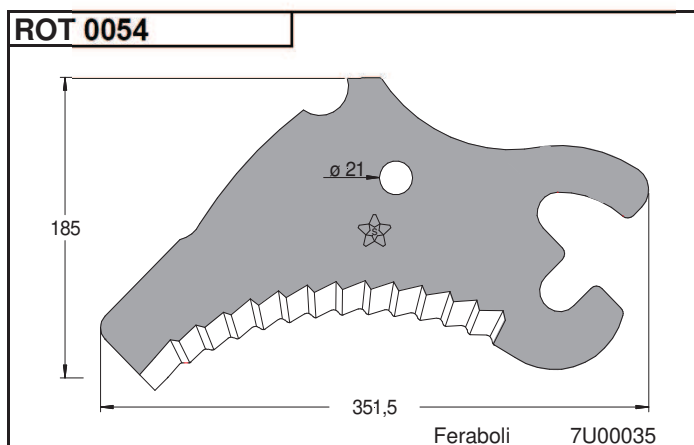
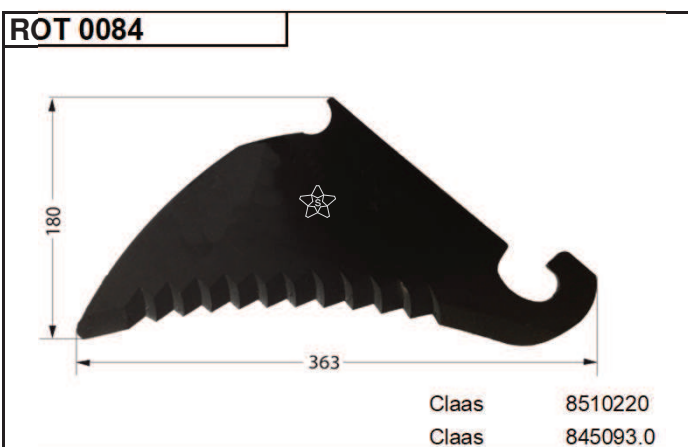
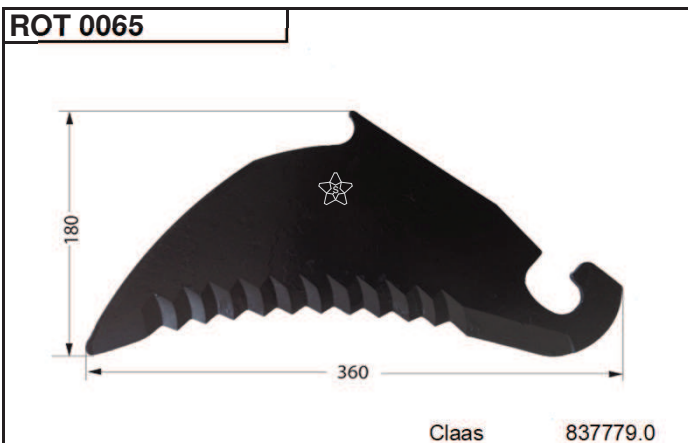

COLTELLI PER ROTOPRESSE- KNIVES FOR ROUND BALERS
COUTEAUX POUR PRESSES DES BALLES CYLINDRIQUES - MESSER FÜR BALLENPRESSEN
CUCHILLAS ROTOEMPACADORA - НОЖИ ДЛЯ ПРЕСС-ПОДБОРЩИКА

Codice

Adattabili a:

Codice

Adattabili a:

ROT 0080

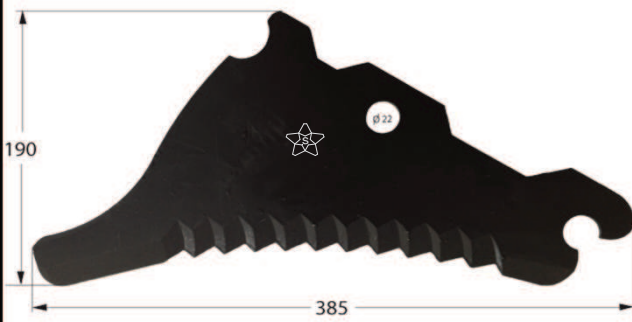

John Deere CC 45488

ROT 0081

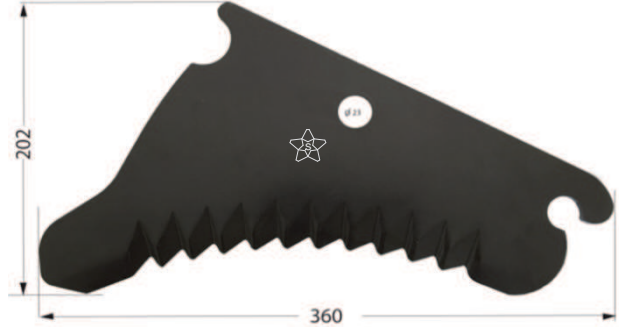

John Deere CC 52821

ROT 0085



Krone 0279-349
 Krone 2777610
 John Deere LCD 277 761

ROT 0094



Krone 2857773
 Krone 287808.2

ROT 0096



Krone Comprima 200611143

ROT 0051

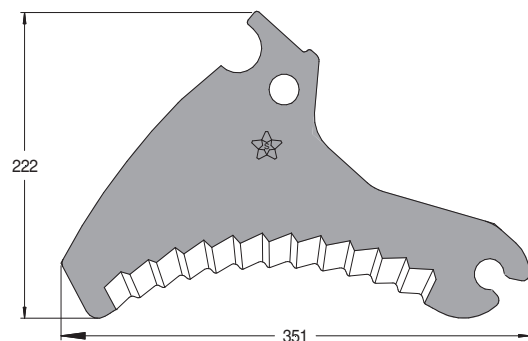

Laverda 3005955
 Case III 3005891

ROT 0083



McHale CKN 00014

ROT 0086



McHale CKN 00014 N



COLTELLI PER ROTOPRESSE- KNIVES FOR ROUND BALERS
COUTEAUX POUR PRESSES DES BALLES CYLINDRIQUES - MESSER FÜR BALLENPRESSEN
CUCHILLAS ROTOEMPACADORA - НОЖИ ДЛЯ ПРЕСС-ПОДБОРЩИКА

Codice

Adattabili a:

Codice

Adattabili a:

ROT 0050



immagine non disponibile

New Holland 84058385

ROT 0055



New Holland 84024222
Laverda 410.000.228

ROT 0087



New Holland 84056505

ROT 0088



New Holland 84058219

ROT 0052

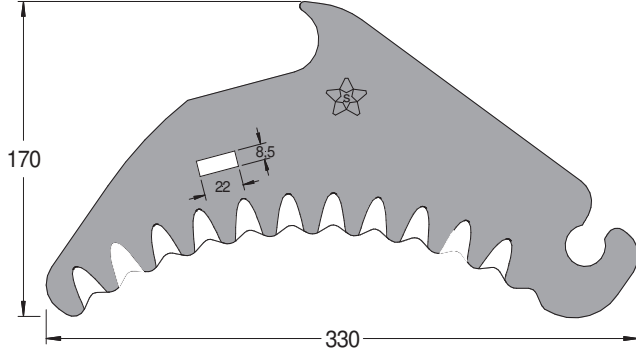

Supertino

ROT 0074



Welger 0982.21.01.00
Welger 0982210100

ROT 0075



immagine non disponibile

Welger 0982.21.04.00
Welger 0982210400

ROT 0082



Welger 0982.21.09.00
Welger 0982210900



COLTELLI PER ROTOPRESSE- KNIVES FOR ROUND BALERS
COUTEAUX POUR PRESSES DES BALLES CYLINDRIQUES - MESSER FÜR BALLENPRESSEN
CUCHILLAS ROTOEMPACADORA - НОЖИ ДЛЯ ПРЕСС-ПОДБОРЩИКА

Codice

Adattabili a:

Codice

Adattabili a:

ROT 0100



immagine
non disponibile

Claas 8661250

ROT 0101



Kuhn Z 4533760 (TN)

ROT 0103



CNH 87649287 (TN)
CNH 87036000

ROT 0104



John Deere CC126575 (TN)

ROT 0105



Krone 200715720
Krone 200730770 (TN)

ROT 0109

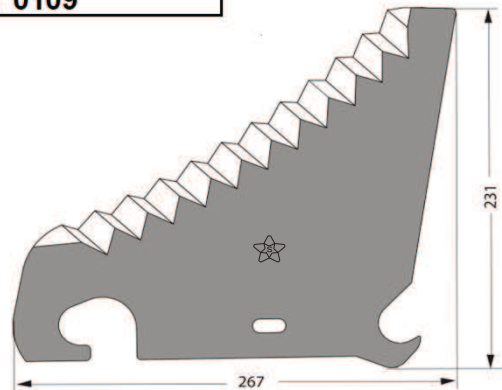

Case 84056426

ROT 0110



Massey Ferguson 700721367

ROT 0111



Krone Comprima 202608661



COLTELLI PER ROTOPRESSE- KNIVES FOR ROUND BALERS
COUTEAUX POUR PRESSES DES BALLEES CYLINDRIQUES - MESSER FÜR BALLENPRESSEN
CUCHILLAS ROTOEMPACADORA - НОЖИ ДЛЯ ПРЕСС-ПОДБОРЩИКА

Codice

Adattabili a:

Codice

Adattabili a:

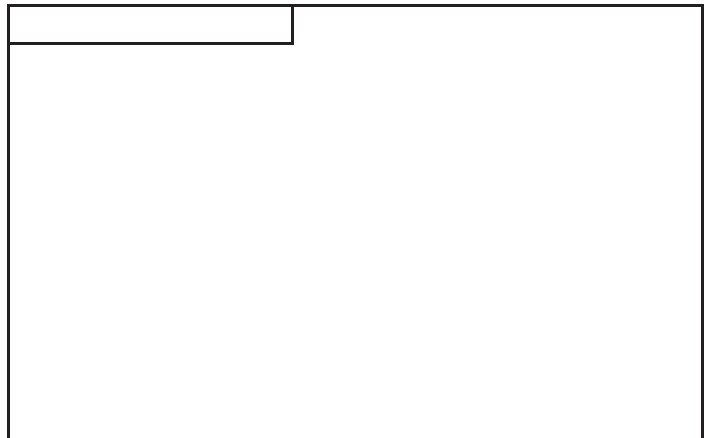
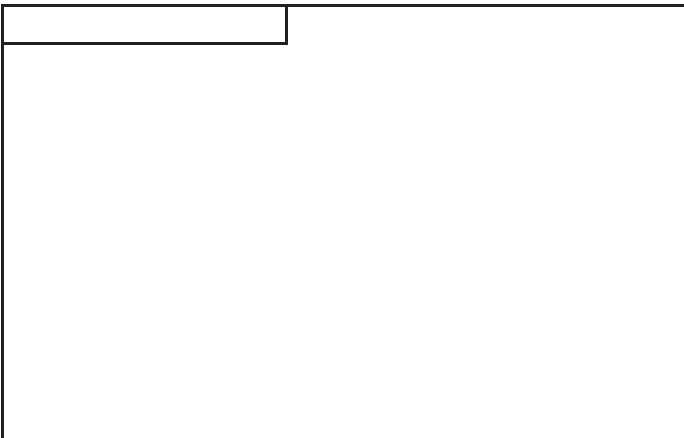
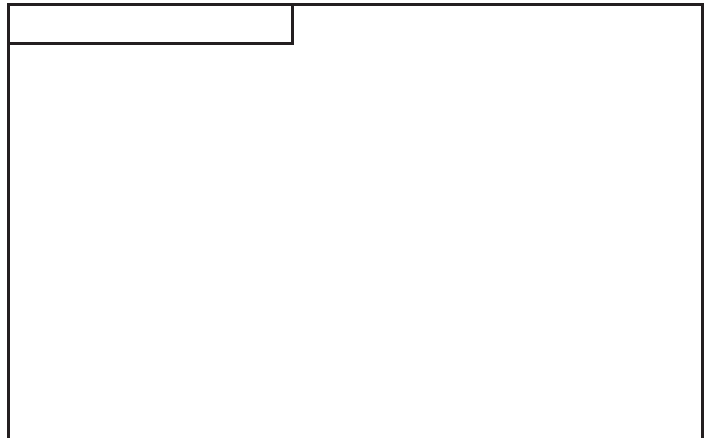
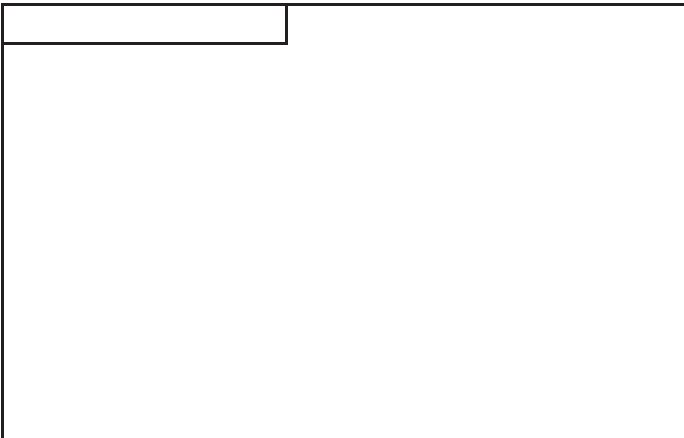
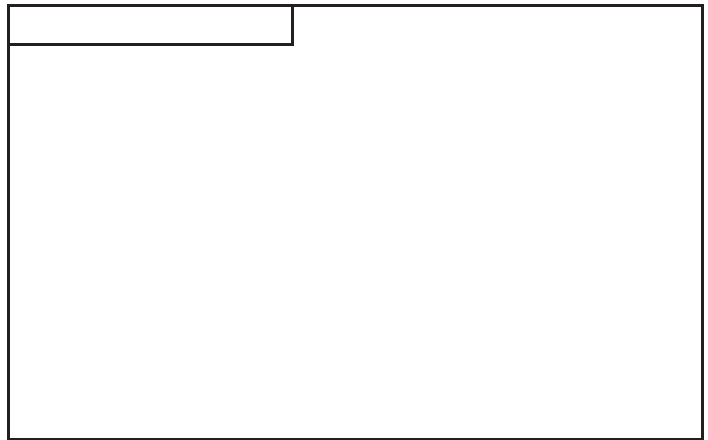
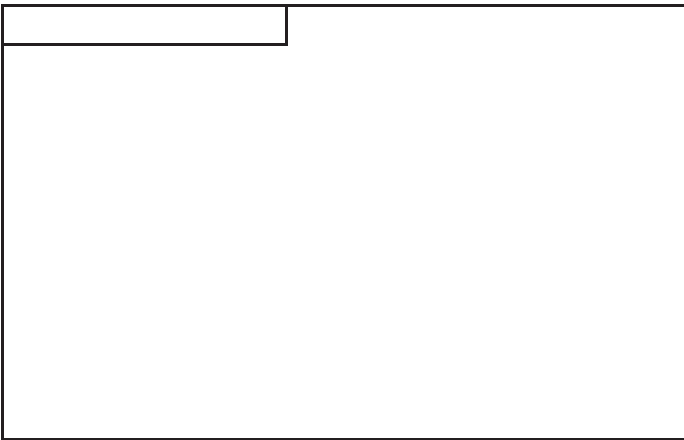
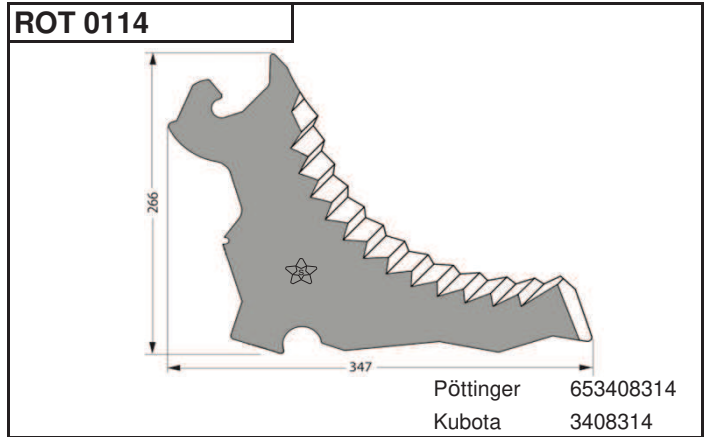
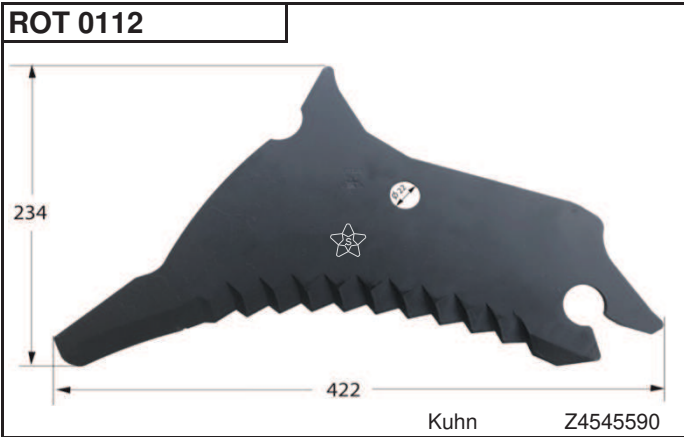

COLTELLI PER AUTOCARICANTI - LOADING TRAILERS
COUTEAUX POUR REMORQUES AUTOCHARGEUSES - MESSER FÜR LADEWAGEN
CUCHILLAS AUTOCARGADORES - САМОЗАГРУЗОЧНОЙ МАШИНЫ

Codice

Adattabili a:

Codice

Adattabili a:

ROT 0089

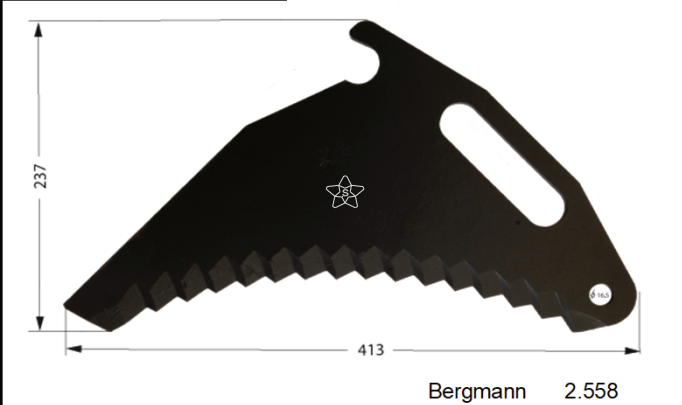

ROT 0090



ROT 0091



ROT 0057



ROT 0058



ROT 0064



ROT 0066

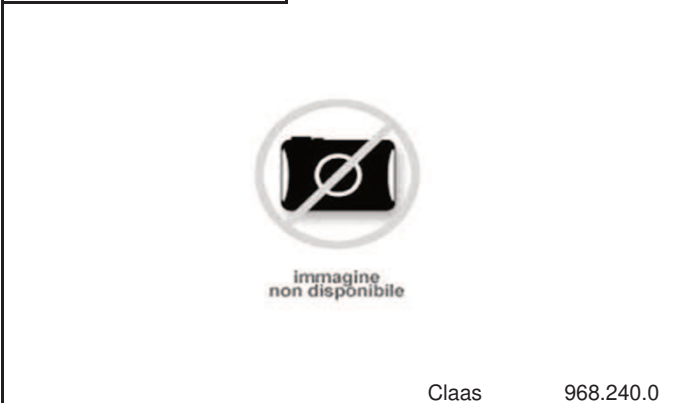

ROT 0073



COLTELLI PER AUTOCARICANTI - LOADING TRAILERS
COUTEAUX POUR REMORQUES AUTOCHARGEUSES - MESSER FÜR LADEWAGEN
CUCHILLAS AUTOCARGADORES - САМОЗАГРУЗОЧНОЙ МАШИНЫ

Codice

Adattabili a:

Codice

Adattabili a:

ROT 0092



ROT 0059



ROT 0060

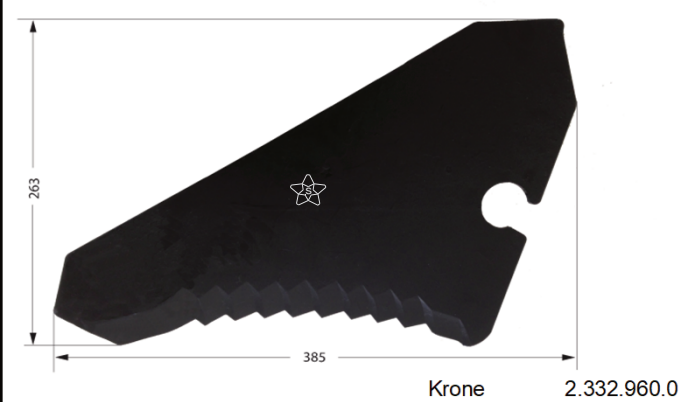

ROT 0061



ROT 0062



ROT 0063



ROT 0095 A

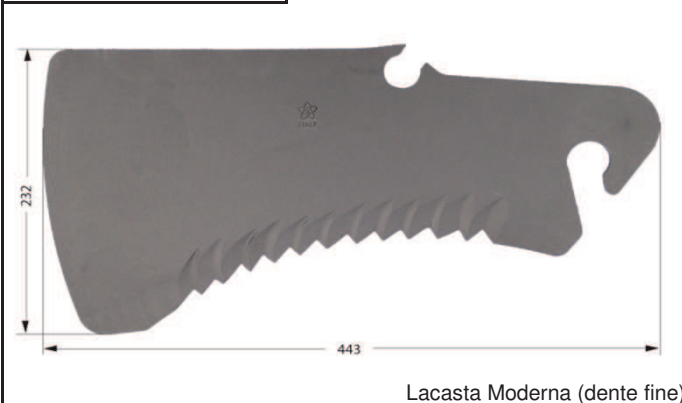

ROT 0095 B



COLTELLI PER AUTOCARICANTI - LOADING TRAILERS
COUTEAUX POUR REMORQUES AUTOCHARGEUSES - MESSER FÜR LADEWAGEN
CUCHILLAS AUTOCARGADORES - САМОЗАГРУЗОЧНОЙ МАШИНЫ

Codice

Adattabili a:

Codice

Adattabili a:

ROT 0076



ROT 0077



ROT 0078



ROT 0056



ROT 0068



ROT 0069



ROT 0070

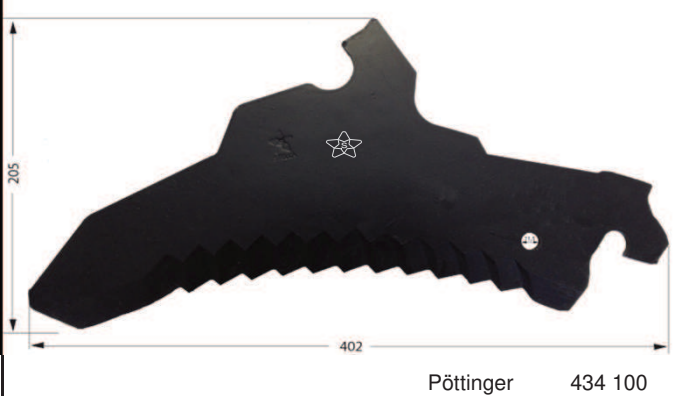

ROT 0093

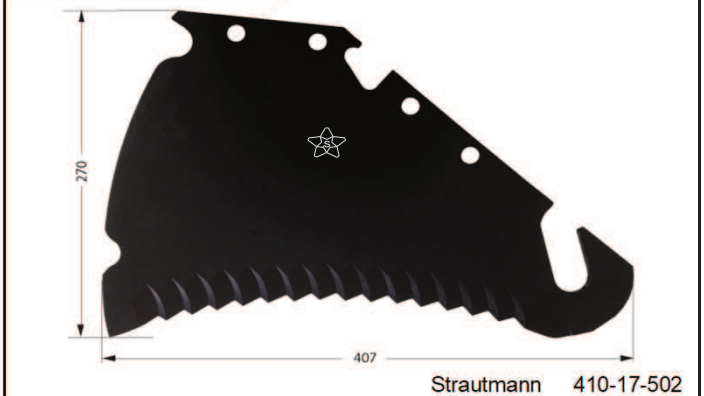

COLTELLI PER AUTOCARICANTI - LOADING TRAILERS
COUTEAUX POUR REMORQUES AUTOCHARGEUSES - MESSER FÜR LADEWAGEN
CUCHILLAS AUTOCARGADORES - САМОЗАГРУЗОЧНОЙ МАШИНЫ

Codice

Adattabili a:

Codice

Adattabili a:

ROT 0097



ROT 0098



ROT 0099



ROT 0102



ST 0030

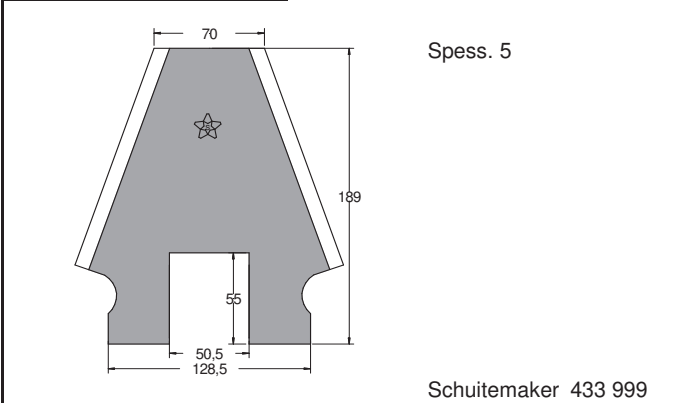

ST 0031

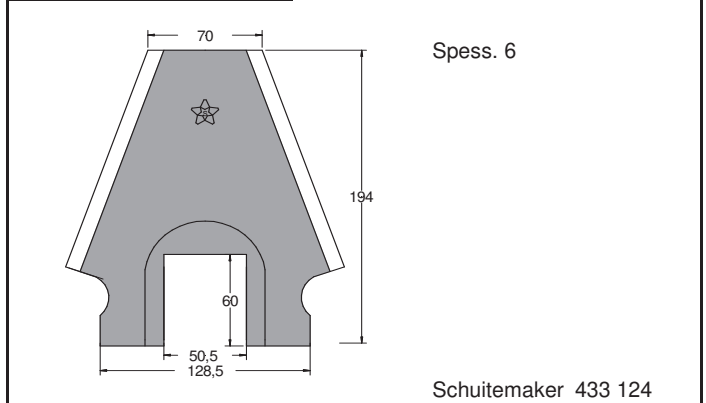

ST 0032

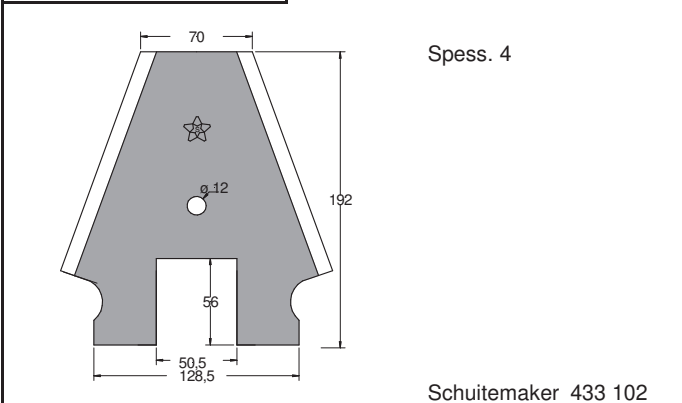

ROT 0116



COLTELLI PER AUTOCARICANTI - LOADING TRAILERS
COUTEAUX POUR REMORQUES AUTOCHARGEUSES - MESSER FÜR LADEWAGEN
CUCHILLAS AUTOCARGADORES - САМОЗАГРУЗОЧНОЙ МАШИНЫ

Codice

Adattabili a:

Codice

Adattabili a:

--	--

--	--

--	--

--	--

--	--

--	--

--	--

--	--



COLTELLI PER AUTOCARICANTI - LOADING TRAILERS
COUTEAUX POUR REMORQUES AUTOCHARGEUSES - MESSER FÜR LADEWAGEN
CUCHILLAS AUTOCARGADORES - САМОЗАГРУЗОЧНОЙ МАШИНЫ

Codice

Adattabili a:

Codice

Adattabili a:

--	--

--	--

--	--

--	--

--	--

--	--

--	--

--	--



PIASTRINE

www.stellalame.com



PIASTRINE - PLAQUES
FINGER PLATTEN - PLAQUES - ЧИСТЯЩИЕ ПЛАСТИНЫ

Codice

Adattabili a:

Codice

Adattabili a:

SS 220 A

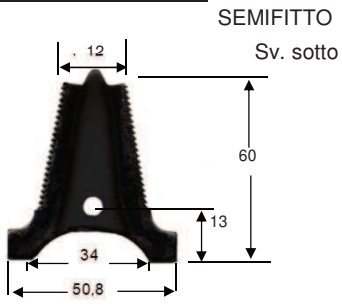

Gaspardo 2002477.1

246 F

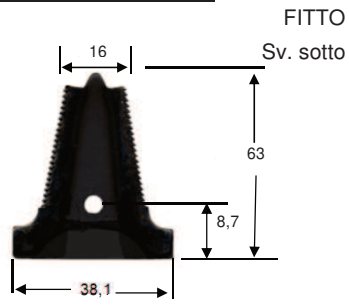

Bcs 58002355.5
 Bedogni - Olimpia
 Bertolini

246 FS

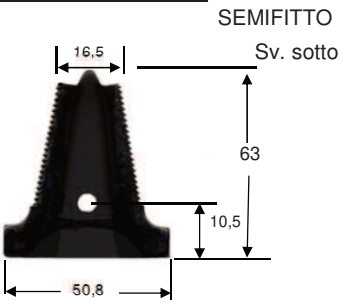

Bcs 58002477.1

LF 41

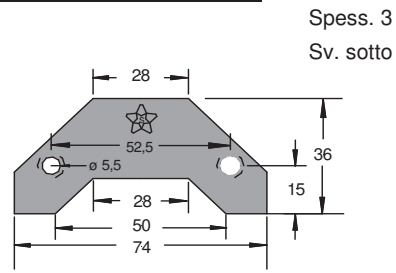

Laverda 3023363

1250

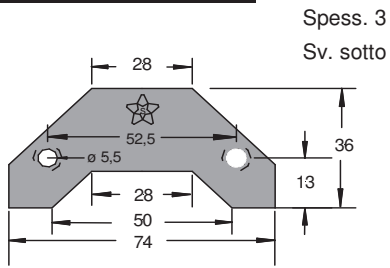

1250 R

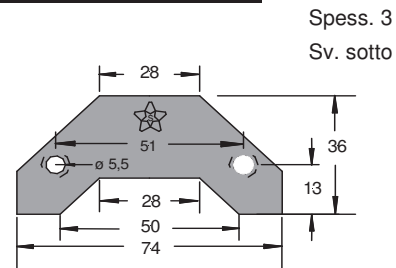

Gaspardo G319

GS 1395

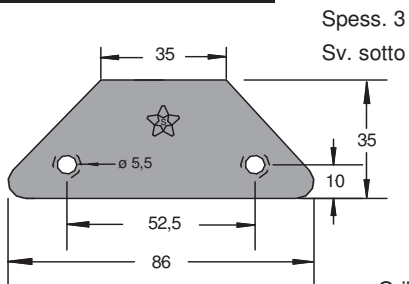

Gribaldi & Salvia 1395

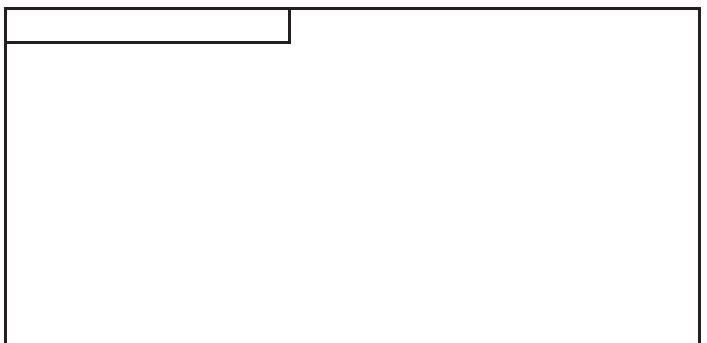
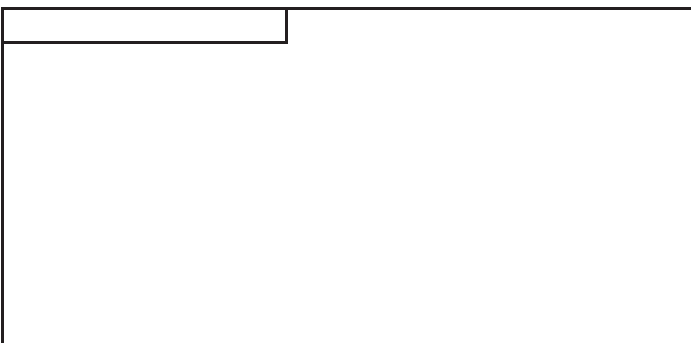

LAME PER DECESPUGLIATORI

www.stellalame.com



LAME PER DECESPUGLIATORI - BLADES FOR BRUSH CUTTER
FREISCHNEIDER MESSER - LAMES POUR DEBROUSSAILLEUSES
DESBROZADORAS - ЛЕЗВИЯ ДЛЯ МОТОКОС

Codice:

DCP-ROM	Diametro	Foro	Spessore
	255	25,4	1,5
	300	25,4	1,5
	255	25,4	2,5
	300	25,4	2,5
	320	25,4	2,5

DCP-DS3P	Diametro	Foro	Spessore
	255	25,4	1,5

DCP-3P	Diametro	Foro	Spessore
	255	25,4	1,5
	255	25,4	2,5
	300	25,4	2,5

DCP-DS3	Diametro	Foro	Spessore
	200	25,4	1,5
	230	25,4	1,5
	255	25,4	1,5

DCP-DS4	Diametro	Foro	Spessore
	200	25,4	1,5
	230	25,4	1,5
	255	25,4	1,5

DCP-DS8P	Diametro	Foro	Spessore
	200	25,4	1,5
	230	25,4	1,5
	255	25,4	1,5

DCP-DS22P	Diametro	Foro	Spessore
	255	25,4	1,5

232 L TA	Diametro	Foro	Spessore
	-	8,2	2,5



KIT LAME PER ROBOT AUTOMATICI

www.stellalame.com



KIT LAME PER ROBOT AUTOMATICI - KIT BLADES FOR AUTOMATIC ROBOTS
MESSERKLINGEN ROBOT MIT SCHRAUBEN - LAMES POUR ROBOTS AUTOMATIQUES
KIT CUCHILLAS PARA ROBOT - КОМПЛЕКТ ЛЕЗВИЙ ДЛЯ РОБОТА ГАЗОНОКОСИЛКИ

Codice:

Adattabili a:

KLR 577606402



Automower Husqvarna (kit lame + viti)

577606402
577606403
577606506
577606503
577606602

535138701
535138702
535138703
535138801
535138802
505127801
505127802

Le lame del presente catalogo sono adattabili alle marche indicate. I codici e le marche sono solo specificate per fini comparativi e di adattabilità.



LAME COMPLETE STELLA PER FALCIATRICI

www.stellalame.com



LAME COMPLETE PER FALCIATRICI - COMPLETE MOWERS KNIFE
MÄHBALKEN - LAMES COMPLÈTES
BARRAS DE CUCHILLAS - СЕКЦИОНАЛЬНЫЕ НОЖИ ДЛЯ КОСИЛКИ



Adattabili BCS

Codice Code	Rif. Originale Original code	Serie Series	N° Sezioni/denti N° sections/fingers	Tipo sezioni/denti Type sections/fingers	Lunghezza Length (Metri / Meters)	Note Notes
SLC 0010	58027092	Duplex	24	27096 S sv.	1,80	Lama con sezioni
SLC 0020	58027093	Duplex	28	27096 S sv.	2,10	Lama con sezioni
SLC 0030	58028911	Duplex Gold	22	28096 S sv.	1,68	Lama con sezioni
SLC 0040	58028910	Duplex Gold	24	28096 S sv.	1,82	Lama con sezioni
SLC 0050	58028912	Duplex Gold	28	28096 S sv.	2,12	Lama con sezioni
SLC 0060	58028914	Duplex Gold	32	28096 S sv.	2,42	Lama con sezioni
SLC 0070	59020716	622	17	212 SF	1,27	Lama con sezioni
SLC 0080	59020688	622	19	212 SF	1,40	Lama con sezioni
SLC 0090	59048926 59058790	Barra Europa Barra Europa rinforzata	19 19	59015 S sv. 50696 S sv.	1,00 1,00	Lama con sezioni
SLC 0100	59048909 59058791	Barra Europa Barra Europa rinforzata	23 23	59015 S sv. 50696 S sv.	1,15 1,15	Lama con sezioni
SLC 0110	59048906 59058792	Barra Europa Barra Europa rinforzata	27 27	59015 S sv. 50696 S sv.	1,35 1,35	Lama con sezioni
SLC 0111	59058728	Barra Laser / BF 2011	19	58716	1,00	Lama con sezioni
SLC 0112	59058739	Barra Laser / BF 2011	23	58716	1,15	Lama con sezioni
SLC 0113	59058740	Barra Laser / BF 2011	27	58716	1,35	Lama con sezioni



LAME COMPLETE PER FALCIATRICI - COMPLETE MOWERS KNIFE
MÄHBALKEN - LAMES COMPLÈTES
BARRAS DE CUCHILLAS - СЕКЦИОНАЛЬНЫЕ НОЖИ ДЛЯ КОСИЛКИ



Adattabili GASPARDO

Codice Code	Rif. Originale Original code	Serie Series	N° Sezioni/denti N° sections/fingers	Tipo sezioni/denti Type sections/fingers	Lunghezza Length (Metri / Meters)	Note Notes
SLC 0120	21120049	FB-925 / 925 S	24	88x3 S f.5,5 sv.	1,75	Lama con sezioni
SLC 0130	21120102	FB-925 / 925 S	28	88x3 S f.5,5 sv.	2,05	Lama con sezioni
SLC 0140	21120053	FB-925 / 925 S	12	21120066	1,75	Lama con denti
SLC 0150	21120106	FB-925 / 925 S	14	21120066	2,05	Lama con denti
SLC 0160	21120240	FB-940	24	88x3 S f.6,25 sv.	1,75	Lama con sezioni
SLC 0170	21120241	FB-940	28	88x3 S f.6,25 sv.	2,05	Lama con sezioni
SLC 0180	21120256	FB-940	12	21120268	1,75	Lama con denti
SLC 0190	21120257	FB-940	14	21120268	2,05	Lama con denti
SLC 0200	13013580	FBR	24	88x3 S f.6,25 sv.	1,75	Lama con sezioni
SLC 0210	13013590	FBR	28	88x3 S f.6,25 sv.	2,05	Lama con sezioni
SLC 0220	13013770	FBR	12	13013270	1,75	Lama con denti
SLC 0230	13013780	FBR	14	13013270	2,05	Lama con denti
SLC 0232	13013772	FBR	12	13013270 / 13014220	1,75	Lama con denti
SLC 0234	13013782	FBR	14	13013270 / 13014220	2,05	Lama con denti



LAME COMPLETE PER FALCIATRICI - COMPLETE MOWERS KNIFE
MÄHBALKEN - LAMES COMPLÈTES
BARRAS DE CUCHILLAS - СЕКЦИОНАЛЬНЫЕ НОЖИ ДЛЯ КОСИЛКИ



Adattabili GASPARDO

Codice Code	Rif. Originale Original code	Serie Series	N° Sezioni/denti N° sections/fingers	Tipo sezioni/denti Type sections/fingers	Lunghezza Length (Metri / Meters)	Note Notes
SLC 0236	13013670	FBR	24	1313540/50	1,75	Lama con sez. doppie
SLC 0238	13013680	FBR	28	1313540/50	2,05	Lama con sez. doppie

Adattabili GRIBALDI & SALVIA

SLC 0240	.017	Superior	24	89x3 S f.5,5 sv. sopra	1,82	Lama con sezioni
SLC 0250	.017	Superior	28	89x3 S f.5,5 sv. sopra	2,12	Lama con sezioni
SLC 0260	.016	Superior	12	087-088	1,82	Lama con denti
SLC 0270	.016	Superior	14	087-088	2,12	Lama con denti

Adattabili BEDOGNI

SLC 0280	12280	Olimpia	17	212 SF	1,27	Lama con sezioni
SLC 0290	12280	Olimpia	19	212 SF	1,40	Lama con sezioni

Adattabili BERTOLINI

SLC 0300	BRF58.124D-125-126		17	212 SF	1,27	Lama con sezioni
SLC 0310	BRF58.124D-125-126		19	212 SF	1,40	Lama con sezioni

ALTRE MARCHE

SU RICHIESTA



LAME COMPLETE STELLA PER MIETITREBBIA

www.stellalame.com



LAME COMPLETE PER MIETITREBBIA - COMPLETE KNIFE
MÄHBALKEN - LAMES COMPLÈTES - BARRAS DE CUCHILLAS -
СЕКЦИОНАЛЬНЫЕ НОЖИ ДЛЯ ЗЕРНОУБОРОЧНЫХ КОМБАЙНОВ



Adattabili LAVERDA

Codice Code	Rif. Originale Original code	Serie Series	N° Sezioni/denti N° sections/fingers	Tipo sezioni/denti Type sections/fingers	Lunghezza Length (Metri / Meters)	Note Notes
SLC 1000	300114585	-	43	242 S	3,10	-
SLC 1005	300114586	-	49	242 S	3,60	-
SLC 1010	300114587	-	57	242 S	4,20	-
SLC 1020	300114588	-	65	242 S	4,80	-
SLC 1030	300114589	-	73	242 S	5,40	-
SLC 1040	300114590	-	81	242 S	6,20	-
SLC 1050	300114591	-	89	242 S	6,60	-
SLC 1055	320900050	-	42	343 SR f.6,8	3,10	-
SLC 1060	321220050	-	49	343 SR f.6,8	3,60	-
SLC 1070	321220150	-	53	343 SR f.6,8	3,90	-
SLC 1080	321220250	-	57	343 SR f.6,8	4,20	-
SLC 1090	321220350	-	65	343 SR f.6,8	4,80	-
SLC 1100	321220450	-	73	343 SR f.6,8	5,40	-



**LAME COMPLETE PER MIETITREBBIA - COMPLETE KNIFE
MÄHBALEN - LAMES COMPLÈTES - BARRAS DE CUCHILLAS -
СЕКЦИОНАЛЬНЫЕ НОЖИ ДЛЯ ЗЕРНОУБОРОЧНЫХ КОМБАЙНОВ**



Adattabili LAVERDA

Codice Code	Rif. Originale Original code	Serie Series	N° Sezioni/denti N° sections/fingers	Tipo sezioni/denti Type sections/fingers	Lunghezza Length (Metri / Meters)	Note Notes
SLC 1110	321220550	-	81	343 SR f.6,8	6,00	-
SLC 1120	321220650	-	89	343 SR f.6,8	6,60	-
SLC 1130	321220750	-	101	343 SR f.6,8	7,60	-
SLC 1140	322704300/V	-	57	222 20	4,20	-
SLC 1150	322704400/V	-	65	222 20	4,80	-
SLC 1160	322704500/V	-	73	222 20	5,40	-
SLC 1170	322704600/V	-	81	222 20	6,00	-
SLC 1180	322704700/V	-	89	222 20	6,60	-
SLC 1190	322704000	-	13	222 20		Spezzione lama centrale
SLC 1200	322704100	-	22	222 20		Spezzione lama finale
SLC 1210	322704200	-	24	222 20		Spezzione lama iniziale
SLC 1220	322709500	-	14	222 20		Spezzione lama finale
SLC 1230	322707150	-	3	222 20		Kit giunzione



**LAME COMPLETE PER MIETITREBBIA - COMPLETE KNIFE
MÄHBALKEN - LAMES COMPLÈTES - BARRAS DE CUCHILLAS -
СЕКЦИОНАЛЬНЫЕ НОЖИ ДЛЯ ЗЕРНОУБОРОЧНЫХ КОМБАЙНОВ**







Adattabili LAVERDA

Codice Code	Rif. Originale Original code	Serie Series	N° Sezioni/denti N° sections/fingers	Tipo sezioni/denti Type sections/fingers	Lunghezza Length (Metri / Meters)	Note Notes
SLC 1300	3113011520	-	55	242 S	4,20	Testa lama 311301110
SLC 1310	3113011530	-	63	242 S	4,80	Testa lama 311301110
SLC 1400	300032600	-	30	242 S	2,30	-
SLC 1410	300117667	-	42	242 S	3,10	-
SLC 1420	300114783	-	53	242 S	3,90	-

LAME COMPLETE PER POMODORO

SLC 0410	-	-	18	ST 6000 ZN sv. sotto	1,635	-
SLC 0420	-	-	20	ST 6000 ZN sv. sotto	1,655	-
SLC 0430	-	-	22	ST 6000 ZN sv. sotto	1,900	-

Teste lama per mietitrebbia

STL 1000	311458660	Laverda		Hole 5,5	-
STL 1010	3212199510	Laverda		Hole 6,5	-
STL 1020	322702950	Laverda		-	-
STL 1030	80753862	New Holland		-	-

Teste lama per falciatrici

STL 2000	56358708	BCS			Barra laser
-----------------	----------	-----	--	--	-------------



Nuovo dente doppio **UNIVERSALE**

Forgiato

www.stellalame.com



- **Facile da montare e smontare**

il dente doppio UNIVERSALE viene montato senza dover rimuovere la barra di taglio dalla testata e non necessita del premilama addizionale grazie alla sua innovativa piastrina incorporata nel pezzo

- **Guida precisa della barra di taglio**

L'utilizzo di acciaio forgiato determina misure uniformi del dente UNIVERSALE che riducono la resistenza della barra di taglio durante il movimento garantendo un taglio ottimale



- **100% intercambiabile**

intercambiabile sulle principali testate mietitrebbia John Deere, Agco, Laverda, Fendt, Rostselmash, Deutz Fahr e su tutte le applicazioni Sch

Adattabile alla nuova cutting unit Stella Testa rossa

- **Maggiore pulizia della testata**

grazie al suo innovativo design non si accumulano detriti vegetali all'interno del dente e la barra di taglio si mantiene sempre pulita

- **Trattato termicamente**

per prestazioni più elevate e durata superiore

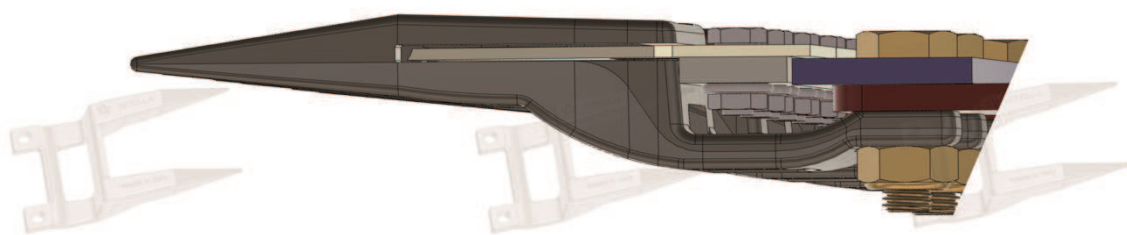

codice prodotto STDM 01 UNIVERSALE

Prodotto brevettato



DENTI PER MIETITREBBIA - GUARDS FOR HARVESTER
MÄHFINGER FÜR MAHDRESCHER - DOIGTS POUR MOISSONNEUSES BATTEUSE
DEDO COSECHADORA

Codice

Adattabili a:

Codice

Adattabili a:

STDM 01 UNIVERSALE



Forgiato

NEW

Sch	410100001
Sch	16500
Deutz Fahr	6503514
Laverda	322702450
John Deere	Z11785
Agco	71386906
Massey Ferguson	

DM 1



Deutz Fahr	6503514
Laverda	322702450
John Deere	Z11785
Agco	71386906
Sch	410100001
Sch	16500
Massey Ferguson	

STDM 02 UNIVERSALE OPEN



Forgiato

NEW

Sch	410300041
Sch	10701.01
Laverda	322702550
John Deere	AH143573
Deutz Fahr	
Agco	71386905/06
Massey Ferguson	

DM 2



Sch	410300041
Sch	10701.01
Laverda	322702550
John Deere	AH143573
Deutz Fahr	
Agco	71386905/06
Massey Ferguson	

DM 3



New Holand 80379720

DM 4

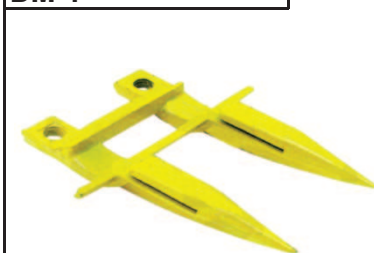

New Holland 80916328

DM 5



Laverda 321115050

DM 6

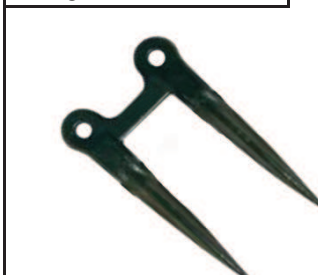

Laverda 301896130

DM 7



John Deere	Z11228
John Deere	H61954

DM 11



Deutz Fahr 111306023600
(06236756)



DENTI PER MIETITREBBIA - GUARDS FOR HARVESTER
MÄHFINGER FÜR MAHDRESCHER - DOIGTS POUR MOISSONNEUSES BATTEUSE
DEDO COSECHADORA

Codice

Adattabili a:

Codice

Adattabili a:

DM 12		Claas 676235 Claas LEXION 626295
--------------	---	-------------------------------------

DM 13		Massey Ferguson 609993M91
--------------	--	---------------------------

DENTI PER FALCIATRICI - GUARDS FOR MOWER
MÄHFINGER FÜR MAHMASCHINEN - DOIGTS POUR FAUCHEUSES
DEDOS PARA SEGADORAS

Codice

Adattabili a:

Codice

Adattabili a:

DF 1		Semifitto BCS 59027624
-------------	---	-------------------------------

DF 2		Fitto BCS 59027622
-------------	--	---------------------------

DF 3		Gaspardo 21120066 (f.5,5) Gaspardo 21120268 (f.6,25) G&S Superior
-------------	---	---

DF 4		Smontabile Gaspardo 13013270 G&S Superior
-------------	--	---

DF 7		New Holland 257635 Hesston 049312
-------------	---	--------------------------------------

--	--	--



LAME SPECIALI

Grazie alla pluriennale esperienza nel settore dei sistemi di taglio Stella studia e realizza numerosi tipi di lame ad alte prestazioni. Sono infatti prodotte negli stabilimenti Stella le lame speciali montate nei vari settori industriali.

L'ufficio Engineering di Stella collabora direttamente con gli uffici tecnici di numerose società italiane ed internazionali al fine di realizzare prodotti di altissima qualità per i più diversi impieghi: agricoltura, giardinaggio, viticoltura, riciclaggio.

La performance per Stella viene prima di tutto.





STELLA srl
Via Badia 30
25060 Cellatica (Brescia)
Italia
Phone +39 030 3732311
Fax. +39 030 3738393
stella@stellalame.com

www.stellalame.com

 made in Italy